

# Installation, Operation, and Maintenance Manual

8124.390/.400/.590 Mega





# Table of Contents

<b>Introduction and Safety</b> .....	<b>3</b>
Introduction.....	3
Safety terminology and symbols.....	3
User safety.....	4
Ex-approved products.....	4
Special hazards.....	5
Protecting the environment.....	6
Spare parts.....	7
Warranty.....	7
<b>Transportation and Storage</b> .....	<b>8</b>
Inspect the delivery.....	8
Inspect the package.....	8
Inspect the unit.....	8
Transportation guidelines.....	8
Lifting.....	8
Temperature ranges for transportation, handling and storage.....	8
Storage guidelines.....	9
<b>Product Description</b> .....	<b>10</b>
Products included.....	10
Pump design.....	10
Monitoring equipment.....	10
Separate overload protection.....	11
The data plate.....	11
<b>Installation</b> .....	<b>13</b>
Install the pump.....	13
Install.....	14
Make the electrical connections.....	15
Prepare the SUBCAB® cables.....	16
Mount the steel hose at the cable entry.....	18
Connect the motor cable to the pump.....	20
Cable charts.....	22
Check the impeller rotation: Pumps without built-in motor protection.....	25
Check the phase sequence: Pumps with built-in motor protection.....	26
<b>Operation</b> .....	<b>29</b>
Start the pump.....	29
Clean the pump.....	30
<b>Maintenance</b> .....	<b>31</b>
Torque values.....	32
Service.....	32
Inspection.....	33
Major overhaul.....	34
Change the oil.....	34
Replace the impeller.....	35
Remove the impeller: H.....	35
Remove the impeller: N.....	37

Install the impeller: H.....	39
Install the impeller: N.....	41
<b>Troubleshooting.....</b>	<b>44</b>
The pump does not start.....	44
The pump does not stop when a level sensor is used.....	45
The pump starts-stops-starts in rapid sequence.....	46
The pump runs but the motor protection trips.....	46
The pump delivers too little or no water.....	47
<b>Technical Reference.....</b>	<b>49</b>
Motor data.....	49
Application limits.....	49
Specific motor data.....	50
Dimensions and weights: Version code 390/400, N.....	51
Dimensions and weights: Version code 390/400, H.....	52
Dimensions and weights: Version code 590.....	53
Performance curves: Version code 390.....	54
Performance curves: Version code 400/590.....	55

# Introduction and Safety

## Introduction

### Purpose of the manual

The purpose of this manual is to provide necessary information for working with the unit. Read this manual carefully before starting work.

### Read and keep the manual

Save this manual for future reference, and keep it readily available at the location of the unit.

### Intended use



#### **WARNING:**

Operating, installing, or maintaining the unit in any way that is not covered in this manual could cause death, serious personal injury, or damage to the equipment and the surroundings. This includes any modification to the equipment or use of parts not provided by Grindex. If there is a question regarding the intended use of the equipment, please contact a Grindex representative before proceeding.

### Other manuals

See also the safety requirements and information in the original manufacturer's manuals for any other equipment furnished separately for use in this system.



## Safety terminology and symbols

### About safety messages

It is extremely important that you read, understand, and follow the safety messages and regulations carefully before handling the product. They are published to help prevent these hazards:

- Personal accidents and health problems
- Damage to the product and its surroundings
- Product malfunction



### Hazard levels

Hazard level	Indication
 <b>DANGER:</b>	A hazardous situation which, if not avoided, will result in death or serious injury
 <b>WARNING:</b>	A hazardous situation which, if not avoided, could result in death or serious injury
 <b>CAUTION:</b>	A hazardous situation which, if not avoided, could result in minor or moderate injury

Hazard level	Indication
<b>NOTICE:</b>	Notices are used when there is a risk of equipment damage or decreased performance, but not personal injury.

**Special symbols**

Some hazard categories have specific symbols, as shown in the following table.

Electrical Hazard	Permanent-magnet hazard
 <b>Electrical Hazard:</b>	 <b>CAUTION:</b>

**User safety**

All regulations, codes, and health and safety directives must be observed.

**The site**

- Observe lockout/tagout procedures before starting work on the product, such as transportation, installation, maintenance, or service.
- Pay attention to the risks presented by gas and vapors in the work area.
- Always be aware of the area surrounding the equipment, and any hazards posed by the site or nearby equipment.

**Qualified personnel**

This product must be installed, operated, and maintained by qualified personnel only.

**Protective equipment and safety devices**

- Use personal protective equipment as needed. Examples of personal protective equipment include, but are not limited to, hard hats, safety goggles, protective gloves and shoes, and breathing equipment.
- Make sure that all safety features on the product are functioning and in use at all times when the unit is being operated.

**Ex-approved products**

Follow these special handling instructions if you have an Ex-approved unit.

**Personnel requirements**

These are the personnel requirements for Ex-approved products in potentially explosive atmospheres:

- All work on the product must be carried out by certified electricians and Grindex-authorized mechanics. Special rules apply to installations in explosive atmospheres.
- All users must know about the risks of electric current and the chemical and physical characteristics of the gas, the vapor, or both present in hazardous areas.
- Any maintenance for Ex-approved products must conform to international and national standards (for example, IEC/EN 60079-17).

Grindex disclaims all responsibility for work done by untrained and unauthorized personnel.

**Product and product handling requirements**

These are the product and product handling requirements for Ex-approved products in potentially explosive atmospheres:

- Only use the product in accordance with the approved motor data.
- You must fully submerge the Ex-approved product during normal operation. Dry running during service and inspection is only permitted outside the classified area.
- Before you start work on the product, make sure that the product and the control panel are isolated from the power supply and the control circuit, so they cannot be energized.
- Do not open the product while it is energized or in an explosive gas atmosphere.
- Make sure that thermal contacts are connected to a protection circuit according to the approval classification of the product, and that they are in use.
- Intrinsically safe circuits are normally required for the automatic level-control system by the level regulator if mounted in zone 0.
- The yield stress of fasteners must be in accordance with the approval drawing and the product specification.
- Do not modify the equipment without approval from an authorized Grindex representative.
- Only use parts that are provided by an authorized Grindex representative.
- The thermal detectors fitted to the stator windings shall be connected into the motor control circuit in such a manner as to disconnect the supply to the motor in order to prevent the Temperature Class T3.
- The width of flameproof joints is more than the values specified in the tables of the IEC 60079–1 standard.
- The gap of flameproof joints is less than the values specified in Table 1 of the IEC 60079–1 standard.
- The equipment must be submerged during normal operation.

### **Guidelines for compliance**

Compliance is fulfilled only when you operate the unit within its intended use. Do not change the conditions of the service without the approval of a Grindex representative. When you install or maintain explosion proof products, always comply with the directive and applicable standards (for example, IEC/EN 60079–14).

### **Minimum permitted liquid level**

See the dimensional drawings of the product for the minimum permitted liquid level according to the approval for explosion proof products. If the information is missing on the dimensional drawing, the product must be fully submerged. Level-sensing equipment must be installed if the product can be operated at less than the minimum submersion depth.

### **Monitoring equipment**

For additional safety, use condition-monitoring devices. Condition-monitoring devices include but are not limited to the following:

- Level indicators
- Temperature detectors

## **Special hazards**

### **Working in temporary installations**

Certain industries, such as mining or construction, have a dynamic nature and require temporary installation of equipment. Due to the rugged nature of these applications, normal use of electrical equipment causes wear and tear that can result in insulation breaks, short-circuits, and exposed wires. To maximize safety

when using the unit in rugged applications, the following conditions must be met:

- If electrical cables must be located such that they are at risk of being run over by heavy equipment, then provide mechanical protection to prevent physical damage to the cables.
- Visually inspect electrical equipment before use. Remove from service any equipment with exposed wires or visible damage.
- Use ground-fault circuit interrupters on all receptacles, or have an assured equipment grounding conductor program.

**Biological hazards**

The product is designed for use in liquids that can be hazardous to your health. Observe these rules when you work with the product:

- Make sure that all personnel who may come into contact with biological hazards are vaccinated against diseases to which they may be exposed.
- Observe strict personal cleanliness.



---

**WARNING: Biological Hazard**

Infection risk. Rinse the unit thoroughly with clean water before working on it.

---

**Wash the skin and eyes**

Follow these procedures for chemicals or hazardous fluids that have come into contact with your eyes or your skin:

Condition	Action
Chemicals or hazardous fluids in eyes	<ol style="list-style-type: none"> <li>1. Hold your eyelids apart forcibly with your fingers.</li> <li>2. Rinse the eyes with eyewash or running water for at least 15 minutes.</li> <li>3. Seek medical attention.</li> </ol>
Chemicals or hazardous fluids on skin	<ol style="list-style-type: none"> <li>1. Remove contaminated clothing.</li> <li>2. Wash the skin with soap and water for at least 1 minute.</li> <li>3. Seek medical attention, if necessary.</li> </ol>

**Protecting the environment**

**Emissions and waste disposal**

Observe the local regulations and codes regarding:

- Reporting of emissions to the appropriate authorities
- Sorting, recycling and disposal of solid or liquid waste
- Clean-up of spills

**Exceptional sites**



---

**CAUTION: Radiation Hazard**

Do NOT send the product to Grindex if it has been exposed to nuclear radiation, unless Grindex has been informed and appropriate actions have been agreed upon.

---



## Spare parts



---

**CAUTION:**

Only use the manufacturer's original spare parts to replace any worn or faulty components. The use of unsuitable spare parts may cause malfunctions, damage, and injuries as well as void the warranty.

---

## Warranty

For information about warranty, see the sales contract.

# Transportation and Storage

## Inspect the delivery

### Inspect the package

1. Inspect the package for damaged or missing items upon delivery.
2. Note any damaged or missing items on the receipt and freight bill.
3. File a claim with the shipping company if anything is out of order.  
If the product has been picked up at a distributor, make a claim directly to the distributor.

### Inspect the unit

1. Remove packing materials from the product.  
Dispose of all packing materials in accordance with local regulations.
2. Inspect the product to determine if any parts have been damaged or are missing.
3. If applicable, unfasten the product by removing any screws, bolts, or straps.  
For your personal safety, be careful when you handle nails and straps.
4. Contact the local sales representative if there is any issue.

## Transportation guidelines

### Precautions



---

**DANGER: Crush Hazard**

Moving parts can entangle or crush. Always disconnect and lock out power before servicing to prevent unexpected startup. Failure to do so could result in death or serious injury.

---

### Position and fastening

The unit can be transported either horizontally or vertically. Make sure that the unit is securely fastened during transportation, and cannot roll or fall over.

### Lifting



Always inspect the lifting equipment and tackle before starting any work.

---

**WARNING: Crush Hazard**

1) Always lift the unit by its designated lifting points. 2) Use suitable lifting equipment and ensure that the product is properly harnessed. 3) Wear personal protective equipment. 4) Stay clear of cables and suspended loads.

---

---

**NOTICE:**

Never lift the unit by its cables or hose.

---

## Temperature ranges for transportation, handling and storage

### Handling at freezing temperature

At temperatures below freezing, the product and all installation equipment, including the lifting gear, must be handled with extreme care.

Make sure that the product is warmed up to a temperature above the freezing point before starting up. Avoid rotating the impeller/propeller by hand at

---

temperatures below the freezing point. The recommended method to warm the unit up is to submerge it in the liquid which will be pumped or mixed.

---

**NOTICE:**

Never use a naked flame to thaw the unit.

---

**Unit in as-delivered condition**

If the unit is still in the condition in which it left the factory - all packing materials are undisturbed - then the acceptable temperature range during transportation, handling and storage is:  $-50^{\circ}\text{C}$  ( $-58^{\circ}\text{F}$ ) to  $+60^{\circ}\text{C}$  ( $+140^{\circ}\text{F}$ ).

If the unit has been exposed to freezing temperatures, then allow it to reach the ambient temperature of the sump before operating.

**Lifting the unit out of liquid**

The unit is normally protected from freezing while operating or immersed in liquid, but the impeller/propeller and the shaft seal may freeze if the unit is lifted out of the liquid into a surrounding temperature below freezing.

Units equipped with an internal cooling system are filled with a mixture of water and 30% glycol. This mixture remains a flowing liquid at temperatures down to  $-13^{\circ}\text{C}$  ( $9^{\circ}\text{F}$ ). Below  $-13^{\circ}\text{C}$  ( $9^{\circ}\text{F}$ ), the viscosity increases such that the glycol mixture will lose its flow properties. However, the glycol-water mixture will not solidify completely and thus cannot harm the product.

Follow these guidelines to avoid freezing damage:

1. Empty all pumped liquid, if applicable.
2. Check all liquids used for lubrication or cooling, both oil and water-glycol mixtures, for the presence of unacceptable amounts of water. Change if needed.

## Storage guidelines

**Storage location**

The product must be stored in a covered and dry location free from heat, dirt, and vibrations.

---

**NOTICE:**

Protect the product against humidity, heat sources, and mechanical damage.

---

**NOTICE:**

Do not place heavy weights on the packed product.

---

**Long-term storage**

If the unit is stored more than six months, then the following apply:

- Before operating the unit after storage, it must be inspected with special attention to the seals and the cable entry.
- The impeller/propeller must be rotated every other month to prevent the seals from sticking together.

# Product Description

## Products included

Pump model	Standard	EX	MSHA	Drainage	Sludge
Mega INOX 8124.390	X			X	
Mega 8124.400	X			X	
Mega 8124.590		X			X

## Pump design

The pump is submersible, and driven by an electric motor.

### Intended use

The product is intended for moving waste water, sludge, raw and clean water. Always follow the limits given in [Application limits](#). If there is a question regarding the intended use of the equipment, please contact a Grindex representative before proceeding.



### **DANGER: Explosion/Fire Hazard**

Special rules apply to installations in explosive or flammable atmospheres. Do not install the product or any auxiliary equipment in an explosive zone unless it is rated explosion-proof or intrinsically-safe. If the product is EN/ATEX-, MSHA- or FM-approved, then see the specific EX information in the Safety chapter before taking any further actions.

### **NOTICE:**

Do NOT use the unit in highly corrosive liquids.

For information about pH, see [Application limits](#).

### Particle size

The pump can handle liquid containing particles that correspond to the holes in the strainer.

Number of holes	Hole dimensions
H: 867 N: 1905	10×10 mm (0.4×0.4 in)

### Pressure class

N	Medium head
H	High head

### Impeller type

Wear resistant

## Monitoring equipment

The following applies to the monitoring equipment of the pump:

- The stator incorporates thermal contacts connected in series that activate the alarm at overtemperature.
- The thermal contacts open at 125°C (257°F) and close at 95°C (203°F).
- The bearing temperature is also monitored by a Pt100 transducer sensor.

## Separate overload protection

Pumps without built-in motor protection must be provided with separate overload protection. Pumps without built-in motor protection have the following label:



This pump must be used with separate overload protection in accordance with technical data.

## The data plate

### Introduction

The data plate is a metal label located on the main body of the pump. The data plate lists key product specifications.

### The data plate

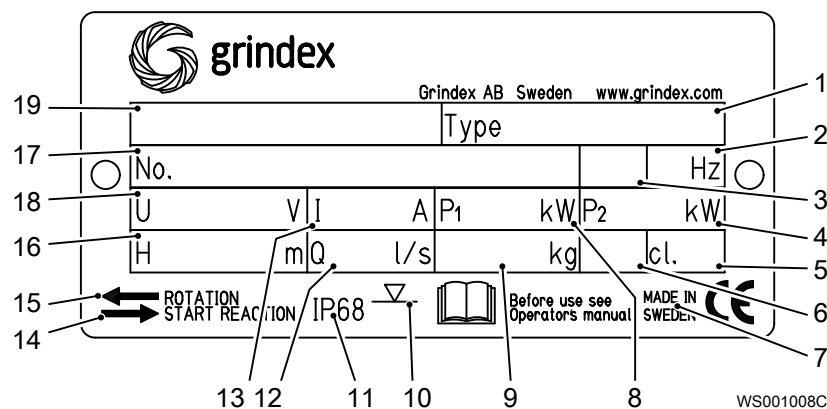

1. Pump type number
2. Frequency
3. Phases, type of current
4. Rated shaft power
5. Thermal class
6. Locked rotor code-letter
7. Country of origin
8. Maximum power consumption
9. Product weight
10. Maximum submersion depth
11. Degree of protection
12. Maximum capacity
13. Rated current
14. Direction of the start reaction
15. Direction of the impeller rotation
16. Maximum head

- 17. Serial number
- 18. Rated voltage
- 19. Pump model

# Installation

## Install the pump

Before starting work, make sure that the safety instructions in the chapter *Introduction and Safety* (page 3) have been read and understood.



### **DANGER: Electrical Hazard**

Before starting work on the unit, make sure that the unit and the control panel are isolated from the power supply and cannot be energized. This applies to the control circuit as well.



### **DANGER: Inhalation Hazard**

Before entering the work area, make sure that the atmosphere contains sufficient oxygen and no toxic gases.

## Hazardous atmospheres



### **DANGER: Explosion/Fire Hazard**

Special rules apply to installations in explosive or flammable atmospheres. Do not install the product or any auxiliary equipment in an explosive zone unless it is rated explosion-proof or intrinsically-safe. If the product is EN/ATEX-, MSHA- or FM-approved, then see the specific EX information in the Safety chapter before taking any further actions.



### **WARNING: Explosion/Fire Hazard**

Do not install CSA-approved products in locations that are classified as hazardous in the National Electric Code(TM), ANSI/NFPA 70-2005.

## Authority regulation

Vent the tank of a sewage station in accordance with local plumbing codes.

## Sedimentation prevention

In order to avoid sedimentation when the pumped liquid contains solid particles, the velocity of the liquid in the discharge line must exceed a certain value. Choose applicable minimum velocity from the table, and choose proper dimension of the discharge line accordingly.

Mixture	Minimum velocity, meter per second (feet per second)
Water + coarse gravel	4 (13)
Water + gravel	3.5 (11)
Water + sand, particle size <0.6 mm (0.024 in)	2.5 (8.2)
Water + sand, particle size <0.1 mm (0.004 in)	1.5 (4.9)

For more permanent installations with a heavily contaminated pumped liquid, a settling pump-sump is recommended.

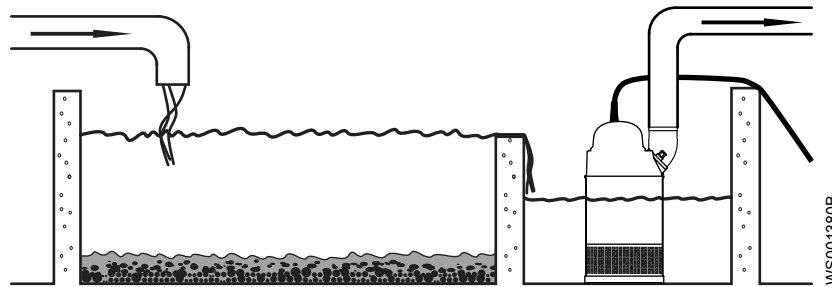

Figure 1: Settling pump-sump

## Fasteners

- Only use fasteners of the proper size and material.
- Replace all corroded fasteners.
- Make sure that all fasteners are properly tightened and that there are no missing fasteners.

## Install

The pump is transportable and intended to operate either completely or partially submerged in the pumped liquid. The pump is equipped with a connection for hose or pipe.

These requirements and instructions only apply when the installation is made according to the dimensional drawing.

1. Run the cable so that it has no sharp bends, is not pinched, and cannot be sucked into the pump inlet.
2. Connect the discharge line.

The discharge line can be run vertically or horizontally, but must be without sharp bends.

3. Lower the pump into the sump.

The cable must not be used for this purpose. You should attach a rope or similar to the handle or the eye bolts for lowering and lifting the pump.

Heavier pumps must be lifted and lowered down by crane. Suspend the pump by the lifting handle or the eye bolts with chains or wires.

4. Place the pump on the base and make sure it cannot fall over or sink.

The base should consist of a plank, a bed of coarse gravel, or a cut-down and perforated oil drum.

Alternatively, the pump can be suspended with a lifting chain just above the sump bottom. Make sure that the pump cannot rotate at start-up or during operation.

5. Connect the motor cable and the starter and monitoring equipment according to the separate instructions.

Make sure that the impeller rotation is correct. For more information, see [Check the impeller rotation: Pumps without built-in motor protection](#) (page 25).



## Make the electrical connections

### General precautions





---

#### **DANGER: Electrical Hazard**

Before starting work on the unit, make sure that the unit and the control panel are isolated from the power supply and cannot be energized. This applies to the control circuit as well.

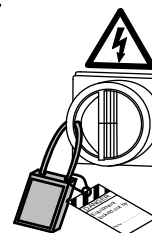
---



---

#### **WARNING: Electrical Hazard**

Risk of electrical shock or burn. A certified electrician must supervise all electrical work. Comply with all local codes and regulations.

---



---

#### **WARNING: Electrical Hazard**

There is a risk of electrical shock or explosion if the electrical connections are not correctly carried out, or if there is fault or damage on the product. Visually inspect equipment for damaged cables, cracked casings or other signs of damage. Make sure that electrical connections have been correctly made.

---



---

#### **WARNING: Crush Hazard**

Risk of automatic restart.

---



---

#### **CAUTION: Electrical Hazard**

Prevent cables from becoming sharply bent or damaged.

---



---

#### **NOTICE:**

Leakage into the electrical parts can cause damaged equipment or a blown fuse. Keep the cable ends dry at all times.

---

### Requirements

These general requirements apply for electrical installation:

- The supply authority must be notified before installing the pump if it will be connected to the public mains. When the pump is connected to the public power supply, it may cause flickering of incandescent lamps when started.
- The mains voltage and frequency must agree with the specifications on the data plate. If the pump can be connected to different voltages, then the connected voltage is specified by a yellow sticker close to the cable entry.
- The fuses and circuit breakers must have the proper rating, and the pump overload protection (motor protection breaker) must be connected and set to the rated current according to the data plate and if applicable the cable chart. The starting current in direct-on-line start can be up to six times higher than the rated current.
- The fuse rating and the cables must be in accordance with the local rules and regulations.
- If intermittent operation is prescribed, then the pump must be provided with monitoring equipment supporting such operation.
- The thermal contacts/thermistors must be in use.

## Cables

These are the requirements to follow when you install cables:

- The cables must be in good condition, not have any sharp bends, and not be pinched.
- The cables must not be damaged and must not have indentations or be embossed (with markings, etc.) at the cable entry.
- The cable entry seal sleeve and washers must conform to the outside diameter of the cable.
- The minimum bending radius must not be below the accepted value.
- If using a cable which has been used before, a short piece must be peeled off when refitting it so that the cable entry seal sleeve does not close around the cable at the same point again. If the outer sheath of the cable is damaged, then replace the cable. Contact a Grindex service shop.
- The voltage drop in long cables must be taken into account. The drive unit's rated voltage is the voltage measured at the cable connection point in the pump.
- For SUBCAB® cables, the twisted pair copper foil must be trimmed.
- All unused conductors must be insulated.

## Grounding (earthing)

Grounding (earthing) must be done in compliance with all local codes and regulations.



### **DANGER: Electrical Hazard**

All electrical equipment must be grounded (earthed). Test the ground (earth) lead to verify that it is connected correctly. Frequently inspect electrical systems to ensure that the path to ground is continuous.



### **WARNING: Electrical Hazard**

If the power cable is jerked loose, then the ground (earth) conductor must be the last conductor to come loose from its terminal. Make sure that the ground (earth) conductor is longer than the phase conductors at both ends of the cable.



### **WARNING: Electrical Hazard**

Risk of electrical shock or burn. You must connect an additional ground- (earth-) fault protection device to the grounded (earthed) connectors if persons are likely to come into contact with liquids that are also in contact with the pump or pumped liquid.

## Ground (earth) conductor length

The ground (earth) conductor must be 100 mm (4.0 in) longer than the phase conductors in the junction box of the unit.

## Prepare the SUBCAB® cables

This section applies to SUBCAB® cables with twisted-pair control cores.

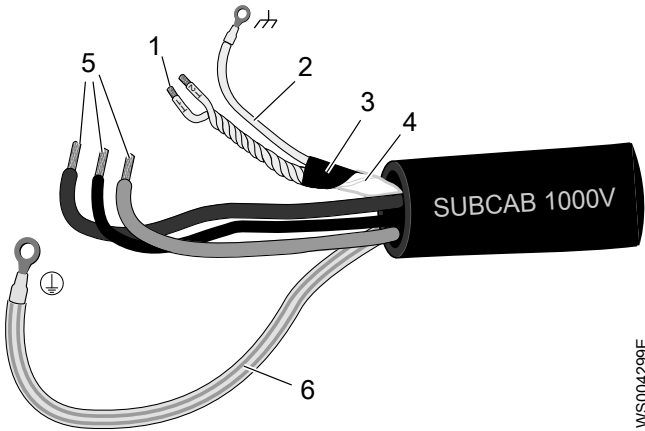
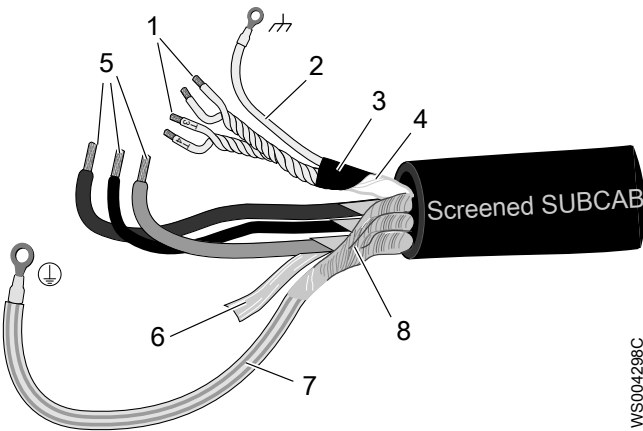
The prepared SUBCAB® cable	The prepared screened SUBCAB® cable
 <p>1. T1+T2 twisted pairs in control element  2. Drain wire in control element (bare copper wire)  3. Screened copper pt-foil  4. Insulation sheath (jacket) or PT-foil for control element  5. Power cores  6. Ground (earth) core</p> <p style="text-align: right;">WS004299E</p>	 <p>1. T1+T2 and T3+T4 twisted pairs in control element  2. Drain wire in control element (bare copper wire)  3. Screened copper pt-foil  4. Insulation sheath (jacket) for control element  5. Power cores  6. Aluminum foil  7. Ground (earth) core with green/yellow shrink hose  8. Uncovered screen/braided wire</p> <p style="text-align: right;">WS004298C</p>

1. Peel off the outer sheath at the end of the cable.
2. Prepare the control element:
  - a) Peel the sheath (if applicable) and the copper foil.  
The copper foil is a screen and is conductive. Do not peel more than necessary, and remove the peeled foil.

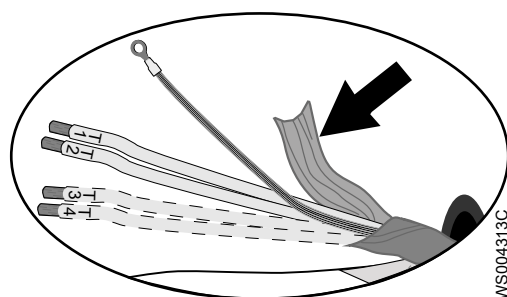

**Figure 2: Copper foil on control element.**

- b) Put a white shrink hose over the drain wire and the cable terminal.
  - c) Fit a cable lug on the drain wire.
  - d) Twist T1+T2 and T3+T4.
  - e) Put a shrink hose over the control element.  
Make sure that the conductive copper foil and drain wire is covered.
3. Prepare the ground (earth) core for SUBCAB™ cable:
  - a) Peel the yellow-green insulation from the ground (earth) core.
  - b) Check that the ground (earth) core is at least 10% longer than the phase cores in the cabinet.
  - c) If applicable, put a cable lug on the ground core.
4. Prepare the ground (earth) core for screened SUBCAB™ cable:
  - a) Untwist the screens around the power cores.
  - b) Put a yellow-green shrink hose over the ground (earth) core.  
Leave a short piece uncovered.
  - c) If applicable, put a cable lug on the screened ground core.

- d) Twist all power core screens together to create a ground (earth) core and fit a cable terminal to the end.
  - e) Check that the ground (earth) core is at least 10% longer than the phase cores in the cabinet.
5. How is the connection to ground (earth) made?
- Screw: Fit cable terminals to the ground (earth) core and the power cores.
  - Terminal block: Leave the core ends as they are.
6. Prepare the main leads:
- a) Remove the aluminum foil around each power core.
  - b) Peel the insulation from each power core.

## Mount the steel hose at the cable entry

Follow these instructions to mount the stainless steel hose over the cable. A generic pump is shown in the figures.

1. Cut the steel hose to the correct length.



### CAUTION: Cutting Hazard

Sharp edges. Wear protective clothing.

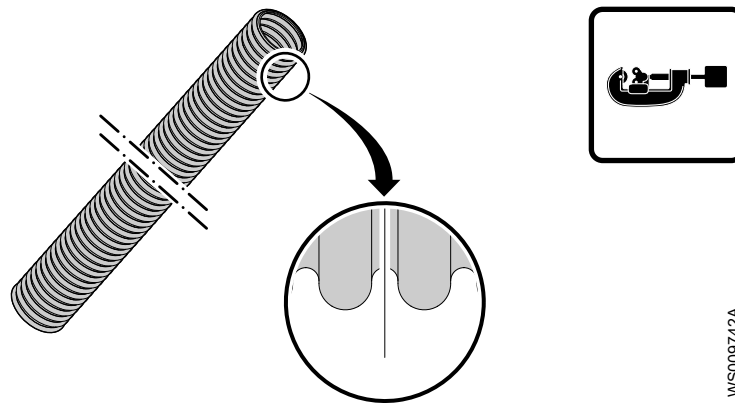

WS009742A

2. Fit the union nut and the clamp ring onto the hose. The clamp ring should be as close to the end as possible.

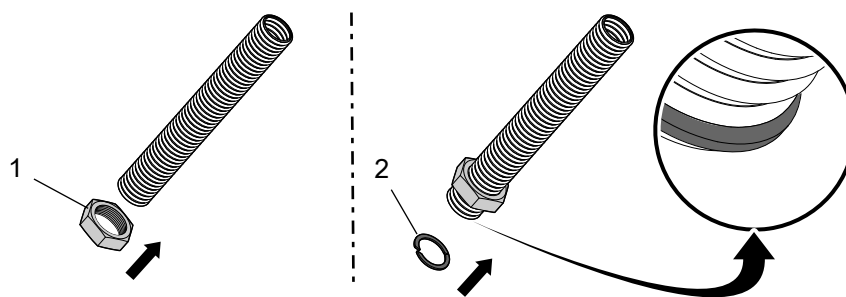

WS009740A

1. Union nut
2. Clamp ring

3. Use the outer thread fitting and the union nut to flatten the end of the hose:
  - a) Place the steel hose so that the bottom rests on the upper surface of the outer thread fitting. Do not use a gasket at this point.
  - b) Using two wrenches, tighten the union nut on the outer thread fitting.

This will flatten the edge of the steel hose which protrudes under the clamp ring.

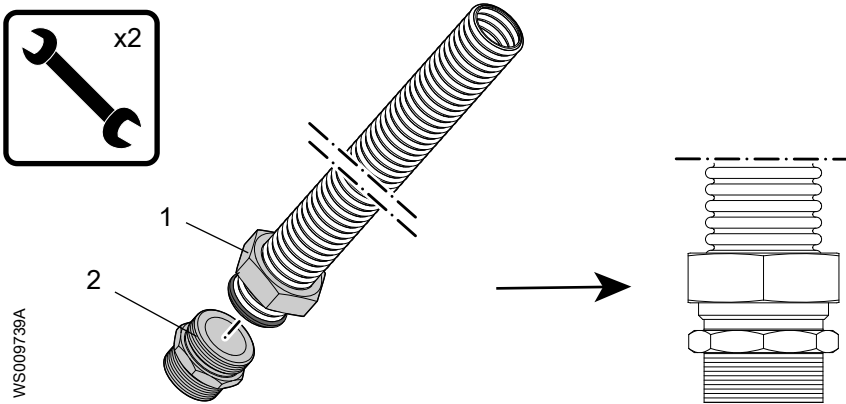

- 1. Union nut
- 2. Outer thread fitting

c) Remove the outer thread fitting.

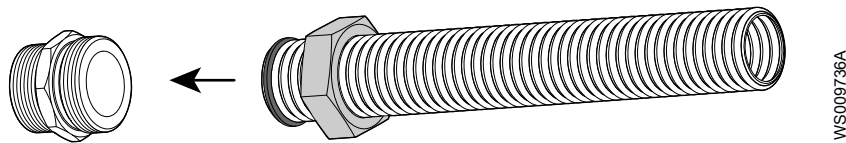

4. Remove the sharp edge at the top end of the steel hose:

a) File the edge so that the opening of the hose is at the widest diameter.

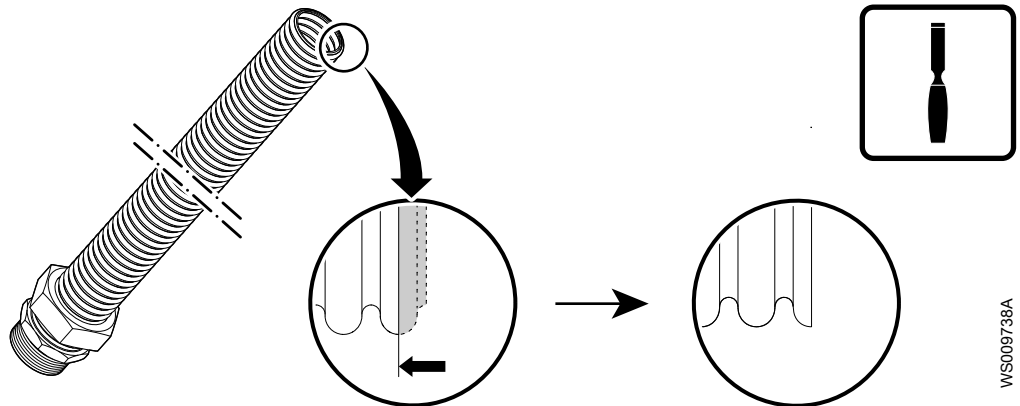

b) Use a hammer to fold the new edge outwards and down.

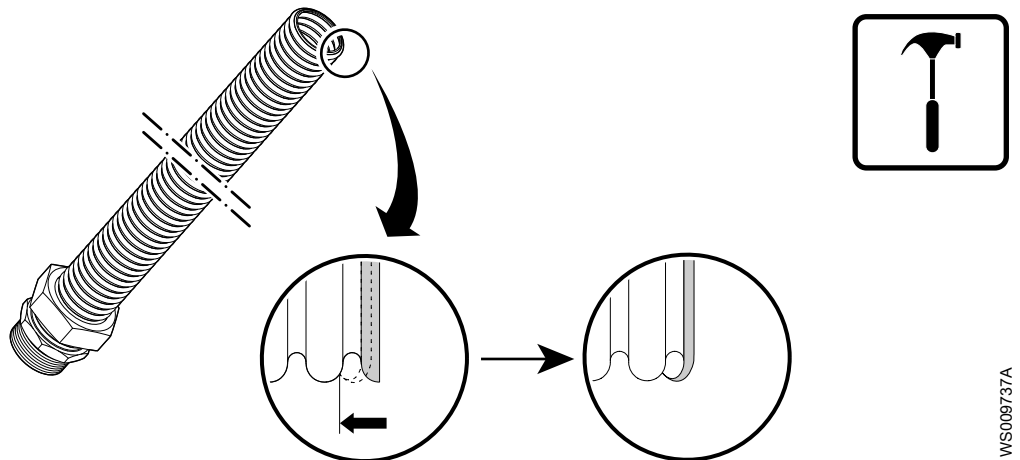

c) Check that the inside rim of the hose has no sharp edges.

5. Mount the outer thread fitting:

a) Apply Teflon to the threads. See the following figure.

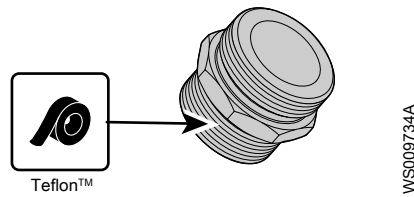

b) Mount the outer thread fitting over the cable.

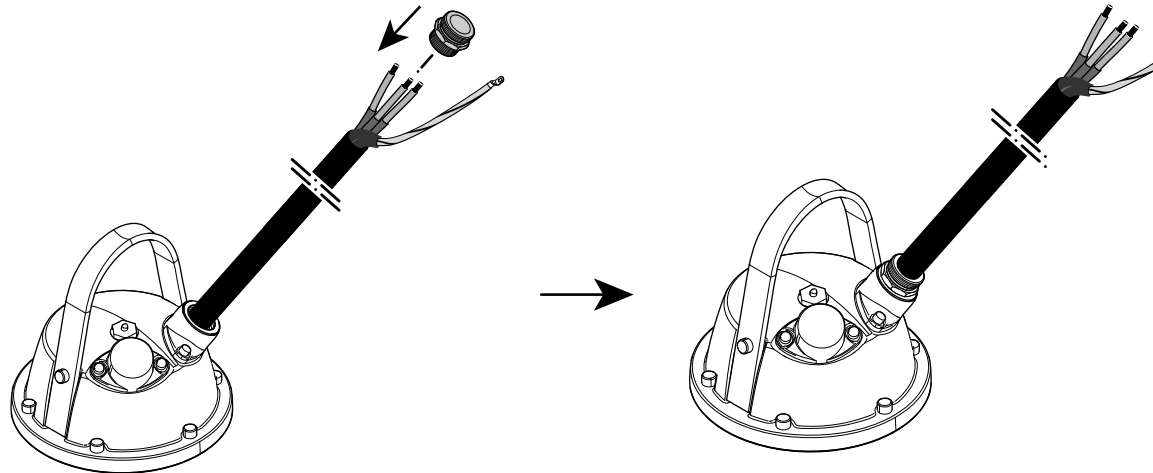

c) Fasten the outer thread fitting at the pump.

6. Mount the steel hose over the cable:

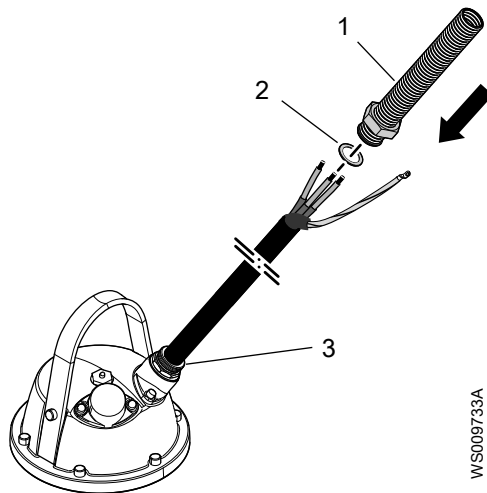

- 1. Steel hose
- 2. Gasket
- 3. Outer thread fitting

- a) Mount a gasket on top of the outer thread fitting.
- b) Mount the steel hose over the cable.
- c) Tighten the union nut onto the outer thread fitting.

## Connect the motor cable to the pump

### NOTICE:

Leakage into the electrical parts can cause damaged equipment or a blown fuse. Keep the end of the motor cable dry at all times.

- 1. Check the data plate to see which connections are required for the power supply:

- Y
  - D
  - Y serial
  - Y parallel
  - Y/D
2. Arrange the connections on the terminal board in accordance with the required power supply.  
Do not use links (jumper strips) with the Y/D start.  
Do not use links (jumper strips) with the 9 stator leads tandem-coupling.
  3. Connect the motor conductors (U1, V1, W1) to the terminal board. Connect the ground (earth) lead.
  4. Make sure that the pump is correctly connected to ground (earth).
  5. Make sure that any thermal contacts incorporated in the pump are properly connected to the terminal board.
  6. Install the cover.
  7. Fasten the screws on the entrance flange so that the cable insertion assembly bottoms out.

After you have connected the motor cable to the pump, connect the motor cable and the control cable to the starter equipment.



---

**DANGER: Explosion/Fire Hazard**

Special rules apply to installations in explosive or flammable atmospheres. Do not install the product or any auxiliary equipment in an explosive zone unless it is rated explosion-proof or intrinsically-safe. If the product is EN/ATEX-, MSHA- or FM-approved, then see the specific EX information in the Safety chapter before taking any further actions.

---

Three thermal contacts are incorporated in the stator. They are normally closed. Thermal contacts must never be exposed to voltages higher than 250 V, breaking current maximum 6 A at a power factor 0.6. It is recommended that the thermal contacts are connected to 24 V over a separate fuse to protect any other automatic equipment.

## Cable charts

### Connection locations

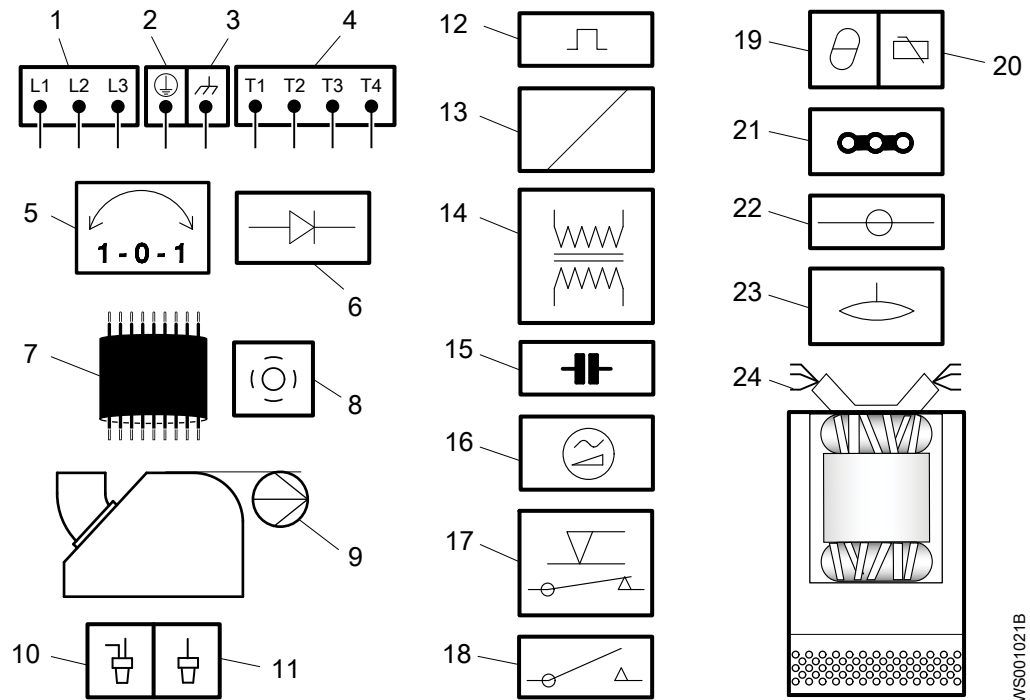

1	Starter equipment and main leads (L1, L2, L3)	13	Coil
2	Ground (earth)	14	Transformer
3	Functional ground	15	Capacitor
4	Control leads (T1, T2, T3, T4)	16	Softstarter
5	Phase shifter	17	Level regulator
6	Diode	18	Contactor, start relay or thermal relay
7	Motor cable	19	Thermal detector in stator
8	Screen	20	Thermal detector in main bearing
9	Pump	21	Jumper
10	Crimp connection	22	Terminal board, terminal plate
11	Crimp isolation	23	Leakage sensor
12	Motor protector	24	Stator leads (U1, U2, U5, U6, V1, V2, V5, V6, W1, W2, W5, W6, Z1, Z5, Z6)

### Color code standard

Code	Description
BN	Brown
BK	Black
WH	White
OG	Orange



---

<b>Code</b>	<b>Description</b>
GN	Green
GNYE	Green-Yellow
RD	Red
GY	Grey
BU	Blue
YE	Yellow

**View of terminal board and sensor connections**

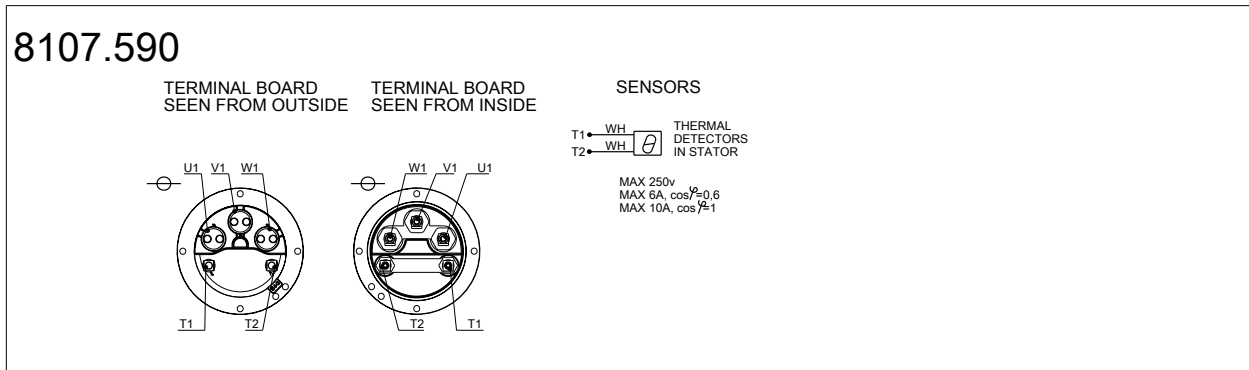
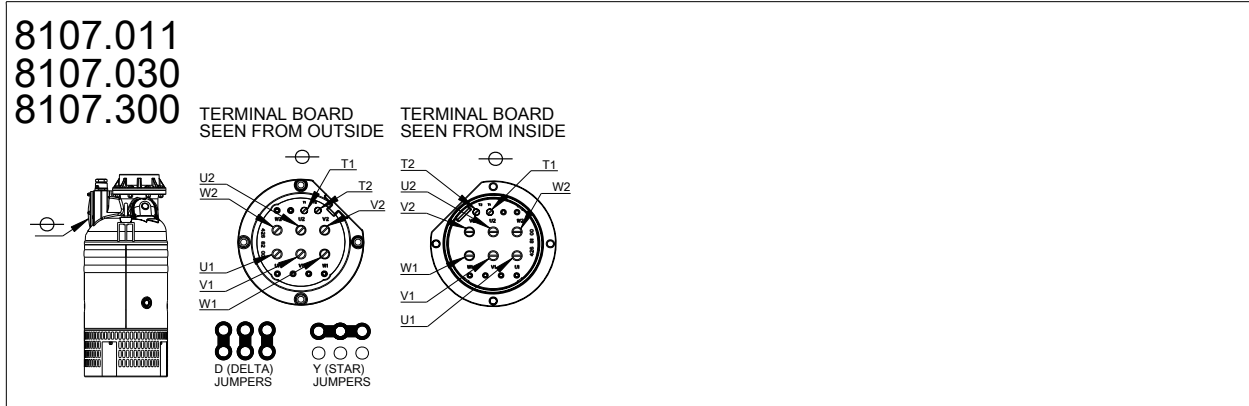
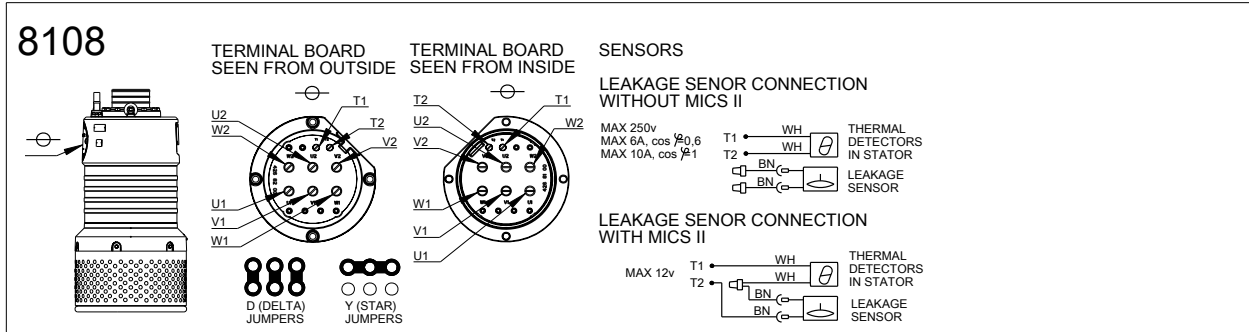
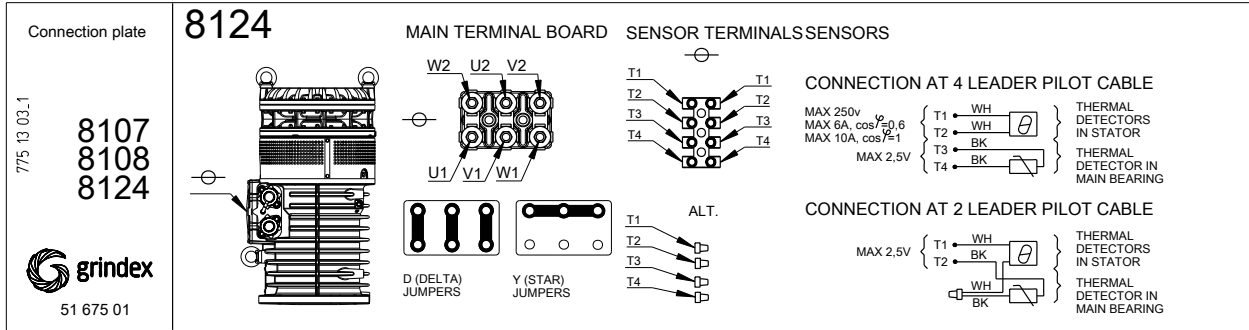

WS008991A

### Motor cable, stator leads and thermal contacts connection to terminal board

775 13 03.1

8107  
8108  
8124

51 675 01

**SYMBOLS AND DENOMINATIONS**

BN=Brown	⊖=Terminal
BK=Black	⊕=Screen
WH=White	⊕=Ground
OG=Orange	⚡=Functional ground
GN=Green	⚡=Connection
GNYE=Green-Yellow	⚡=Crimp isolation
RD=Red	
GY=Grey	
BU=Blue	
YE=Yellow	

GC= Ground check  
A = Cable dimension in cable specification

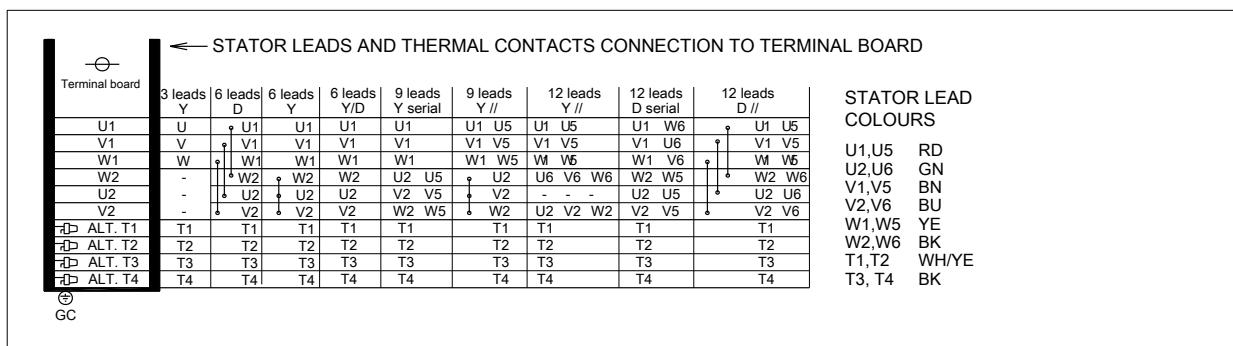
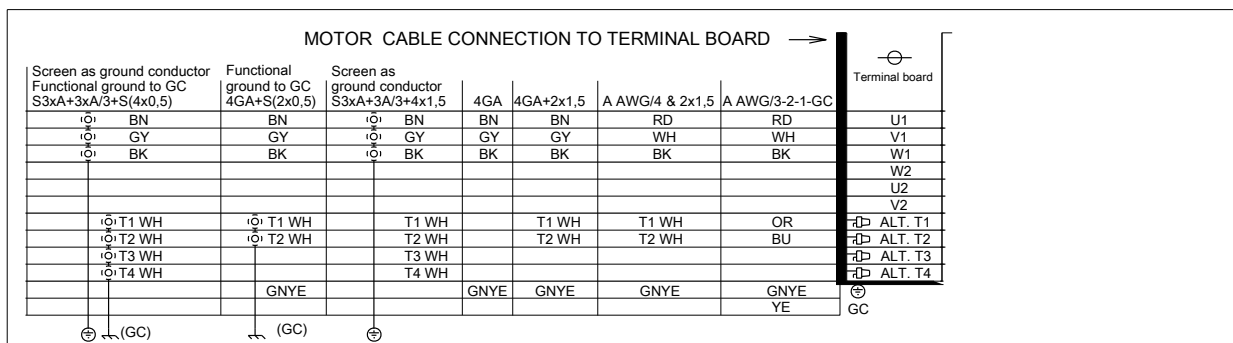
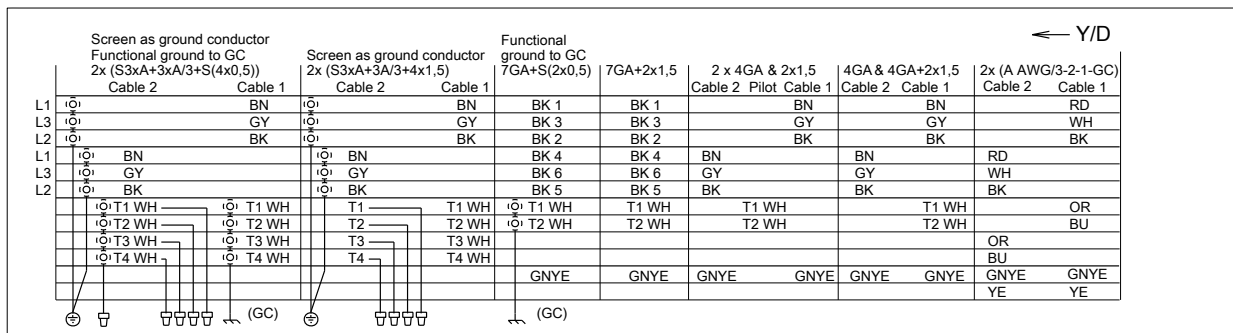

WS008992A

## Check the impeller rotation: Pumps without built-in motor protection

Follow this procedure if your product does not have the rotation control SMART™.



---

**CAUTION: Crush Hazard**

The starting jerk can be powerful. Make sure nobody is close to the unit when it is started.

---

Check the direction of rotation each time the cable has been re-connected and after phase or total supply failure.

1. Start the motor.
2. Stop the motor.
3. Check that the impeller rotates in the correct direction.

When started, the pump will react in the opposite direction to the impeller rotation. See the correct start reaction direction on the stator housing of the pump.

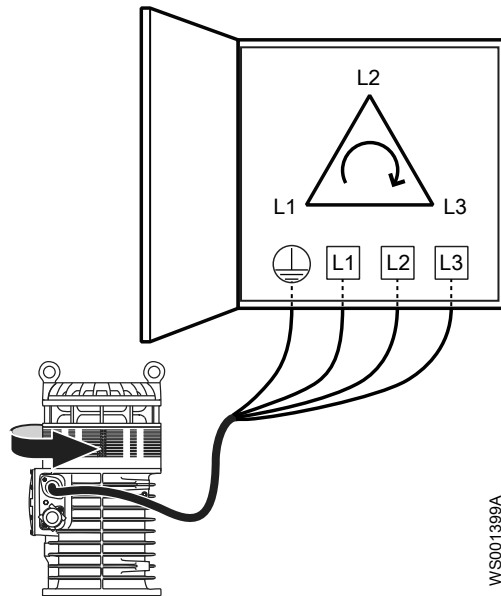

**Figure 3: Start reaction**

4. If the impeller rotates in the wrong direction, then do the following:
  - If the motor has a 3-phase connection, then transpose two phase conductors and repeat this procedure from step 1.

For 3-phase pumps with external starters or without built-in motor protection, the phases must be shifted on the output terminal of the starter.

## Check the phase sequence: Pumps with built-in motor protection

Follow this procedure if your product is equipped with the rotation control SMART™.





---

**CAUTION: Crush Hazard**

The starting jerk can be powerful. Make sure nobody is close to the unit when it is started.

---

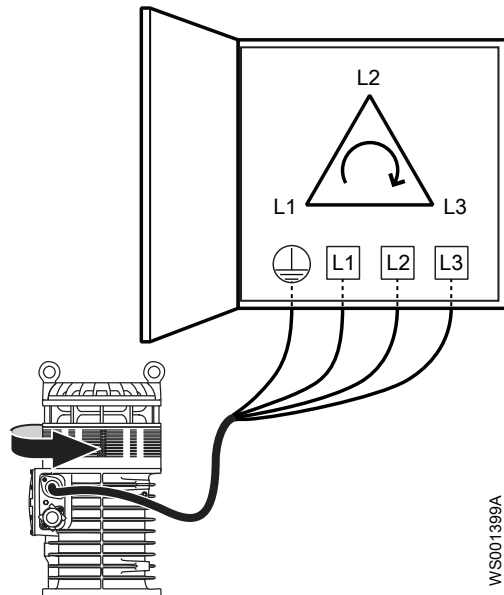
The correct direction of impeller rotation is clockwise when you look at the pump from above. When started, the pump will react in the opposite direction to the impeller rotation.



**Figure 4: Start reaction**

1. Connect the pump to power as follows:

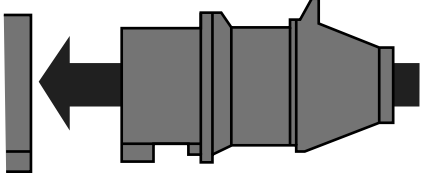
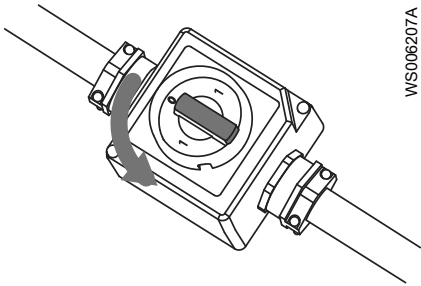
Condition	Action
The pump has a CEE plug with internal phase shifter.	Connect the plug.  WS006205A
The pump has a phase shifter with an on/off switch.	Turn the knob on the phase shifter in either direction.  WS006207A
The pump has neither a CEE plug with internal phase shifter, nor a phase shifter with an on/off switch.	1. Connect the pump to power. 2. Switch on the power.

The pump should start. If it does not, then continue to the next step.

2. If the pump does not start and the fuses are correct, then shift two phases:

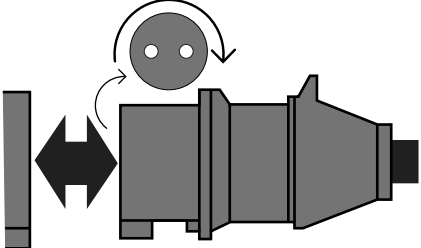
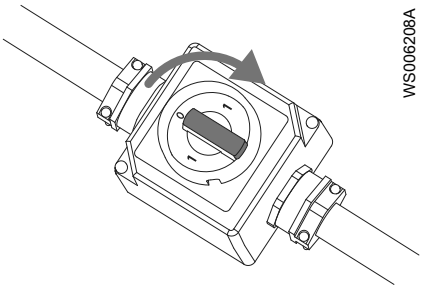
Condition	Action
<p>The pump has a CEE plug with internal phase shifter.</p>	<ol style="list-style-type: none"> <li>1. Pull out the plug.</li> <li>2. Shift two phases.</li> <li>3. Wait until the motor has stopped.</li> <li>4. Connect the plug.</li> </ol>  <p style="text-align: right; font-size: small;">WS006206A</p>
<p>The pump has a phase shifter with an on/off switch.</p>	<ol style="list-style-type: none"> <li>1. Turn the knob on the phase shifter to neutral position.</li> <li>2. Wait until the motor has stopped.</li> <li>3. Turn the knob to the opposite position from before.</li> </ol>  <p style="text-align: right; font-size: small;">WS006208A</p>
<p>The pump has neither a CEE plug with internal phase shifter, nor a phase shifter with an on/off switch.</p>	<p>Transpose two phase leads on the output terminal of the starter.</p>

**NOTICE:**

Do not reverse the phase sequence while the pump is running. Temporarily incorrect rotation can occur, resulting in damage to motor electronics and rotating parts.

The pump should start. If it does not, then contact a certified electrician to check the mains and the junctions.

# Operation

## Precautions

Before taking the unit into operation, check the following:

- All recommended safety devices are installed.
- The cable and cable entry have not been damaged.
- All debris and waste material has been removed.

---

### NOTICE:

Never operate the pump with the discharge line blocked, or the discharge valve closed.

---



---

### WARNING: Crush Hazard

Risk of automatic restart.

---

## Distance to wet areas



---

### WARNING: Electrical Hazard

Risk of electrical shock or burn. You must connect an additional ground- (earth-) fault protection device to the grounded (earthed) connectors if persons are likely to come into contact with liquids that are also in contact with the pump or pumped liquid.

---



---

### CAUTION: Electrical Hazard

Risk of electrical shock or burn. The equipment manufacturer has not evaluated this unit for use in swimming pools. If used in connection with swimming pools then special safety regulations apply.

---

## Noise level

---

### NOTICE:

The sound power level of the product is lower than 70 dB(A). However, in some installations the resulting sound pressure level may exceed 70 dB(A) at certain operating points on the performance curve. Make sure that you understand the noise level requirements in the environment where the product is installed. Failure to do so may result in hearing loss or violation of local laws.

---

## Start the pump



---

### CAUTION: Crush Hazard

The starting jerk can be powerful. Make sure nobody is close to the unit when it is started.

---



---

### NOTICE:

Make sure that the rotation of the impeller is correct. For more information, see Check the impeller rotation.

---

1. Inspect the pump. Check that there is no physical damage to the pump or cables.
2. Check the oil level in the oil housing.

3. Remove the fuses or open the circuit breaker, and check that the impeller can be rotated freely.



---

**WARNING: Crush Hazard**

Never put your hand into the pump housing.

---

4. Check that the monitoring equipment (if any) works.
5. Check that the impeller rotation is correct.
6. Start the pump.

## Clean the pump

The pump must be cleaned if it has been running in very dirty water. If clay, cement or other similar dirt is left in the pump it may clog the impeller and seal, preventing the pump from working.

Let the pump run for a while in clean water, or flush it through the discharge connection.



# Maintenance

## Precautions

Before starting work, make sure that the safety instructions in the chapter *Introduction and Safety* (page 3) have been read and understood.



---

### **DANGER: Crush Hazard**

Moving parts can entangle or crush. Always disconnect and lock out power before servicing to prevent unexpected startup. Failure to do so could result in death or serious injury.

---



---

### **WARNING: Biological Hazard**

Infection risk. Rinse the unit thoroughly with clean water before working on it.

---



---

### **CAUTION: Crush Hazard**

Make sure that the unit cannot roll or fall over and injure people or damage property.

---

Make sure that you follow these requirements:

- Check the explosion risk before you weld or use electrical hand tools.
- Allow all system and pump components to cool before you handle them.
- Make sure that the product and its components have been thoroughly cleaned.
- Make sure that the work area is well-ventilated before you open any vent or drain valves, remove any plugs, or disassemble the unit.
- Do not open any vent or drain valves or remove any plugs while the system is pressurized. Make sure that the pump is isolated from the system and that pressure is relieved before you disassemble the pump, remove plugs, or disconnect piping.

### **Ground continuity verification**

A ground (earth) continuity test must always be performed after service.

### **Maintenance guidelines**

During the maintenance and before reassembly, always remember to perform these tasks:

- Clean all parts thoroughly, particularly O-ring grooves.
- Change all O-rings, gaskets, and seal washers.
- Lubricate all springs, screws, O-rings with grease.

During the reassembly, always make sure that existing index markings are in line.

The reassembled drive unit must always be insulation-tested and the reassembled pump must always be test-run before normal operation.

## Torque values

All screws and nuts must be lubricated to achieve correct tightening torque. Screws that are screwed into stainless steel must have the threads coated with suitable lubricants to prevent seizing.

If there is a question regarding the tightening torques, please contact the local sales and service representative.

### Screws and nuts

Table 1: Stainless steel, A2 and A4, torque Nm (ft-lbs)

Property class	M4	M5	M6	M8	M10	M12	M16	M20	M24	M30
50	1.0 (0.74)	2.0 (1.5)	3.0 (2.2)	8.0 (5.9)	15 (11)	27 (20)	65 (48)	127 (93.7)	220 (162)	434 (320)
70, 80	2.7 (2)	5.4 (4)	9.0 (6.6)	22 (16)	44 (32)	76 (56)	187 (138)	364 (268)	629 (464)	1240 (915)
100	4.1 (3)	8.1 (6)	14 (10)	34 (25)	66 (49)	115 (84.8)	248 (183)	481 (355)	—	—

Table 2: Steel, torque Nm (ft-lbs)

Property class	M4	M5	M6	M8	M10	M12	M16	M20	M24	M30
8.8	2.9 (2.1)	5.7 (4.2)	9.8 (7.2)	24 (18)	47 (35)	81(60)	194 (143)	385 (285)	665 (490)	1310 (966.2)
10.9	4.0 (2.9)	8.1 (6)	14 (10)	33 (24)	65 (48)	114 (84)	277 (204)	541 (399)	935 (689)	1840 (1357)
12.9	4.9 (3.6)	9.7 (7.2)	17 (13)	40 (30)	79 (58)	136 (100)	333 (245)	649 (480)	1120 (825.1)	2210 (1630)

### Hexagon screws with countersunk heads

For hexagon socket head screws with countersunk head, maximum torque for all property classes must be 80% of the values for property class 8.8 above.

## Service

Regular inspection and service of the pump ensures more reliable operation.

Type of service	Purpose	Inspection interval
Inspection	To prevent operational interruptions and machine breakdown. Measures to secure performance and pump efficiency are defined and decided for each individual application. It can include such things as impeller trimming, wear part control and replacement, control of zinc-anodes and control of the stator.	2,000 hours or 1 year, whichever comes first. Applies to normal applications and operating conditions at media (liquid) temperatures < 40°C (104°F).

Type of service	Purpose	Inspection interval
Major overhaul	To secure a long operating lifetime for the product. It includes replacement of key components and the measures taken during an inspection.	4,000 hours or 2 years, whichever comes first. These intervals apply to normal applications and operating conditions at media (liquid) temperatures < 40°C (104°F).

**NOTICE:**

Shorter intervals may be required when the operating conditions are extreme, for example with very abrasive or corrosive applications or when the liquid temperatures exceed 40°C (104°F).

## Inspection

Regular inspection and service of the pump ensures more reliable operation.

Service item	Action
Visible parts on the pump and installation	<ol style="list-style-type: none"> <li>1. Check that all screws, bolts, and nuts are properly tightened.</li> <li>2. Check the condition of the pump casing, strainer, cover, lifting handles, eye bolts, ropes, chains, and wires.</li> <li>3. Check for worn or damaged parts.</li> <li>4. Adjust and/or replace if necessary.</li> </ol>
Pipes, valves, and other peripheral equipment	<ol style="list-style-type: none"> <li>1. Check for worn or damaged parts.</li> <li>2. Adjust and/or replace if necessary.</li> </ol>
Impeller	<ol style="list-style-type: none"> <li>1. Check for worn or damaged parts.</li> <li>2. Adjust and/or replace if necessary.</li> </ol> <p>Wear on the impeller or surrounding parts necessitates fine adjustments of the impeller or replacement of worn parts.</p>
Oil	<p>Check the oil:</p> <ol style="list-style-type: none"> <li>1. Take an oil sample.</li> <li>2. If the oil contains particles, then replace the mechanical seal. Contact an authorized service shop.</li> </ol> <p>Make sure that the volume is filled to the correct level.</p> <p>A smaller amount of water is not harmful for the mechanical seal.</p>
Cable entry	<ol style="list-style-type: none"> <li>1. Check that the following requirements are met: <ul style="list-style-type: none"> <li>– The cable clamps must be properly tightened.</li> <li>– Standard pump version: The cable entry must be firmly tightened into its bottom-most position.</li> <li>– The seal sleeve and the washers must conform to the outside diameter of the cables.</li> </ul> </li> <li>2. Cut off a piece of the cable so that the seal sleeve closes around a new position on the cable.</li> <li>3. Replace the seal sleeve, if necessary.</li> </ol>

<b>Service item</b>	<b>Action</b>
Inspection volume <sup>1</sup>	<ol style="list-style-type: none"> <li>1. Check that the inspection screw is properly tightened.</li> <li>2. Remove the inspection screw.</li> <li>3. Drain all liquid, if any.</li> <li>4. If there is oil in the inspection volume, then empty the oil and check again after one week. If there is oil in the inspection volume again, then replace the mechanical seal. Contact an authorized service shop.</li> <li>5. If there is water in the inspection volume, then check that the inspection screw O-ring is not damaged.</li> </ol>
Cable	<ol style="list-style-type: none"> <li>1. If the outer jacket is damaged, replace the cable.</li> <li>2. Check that the cables do not have any sharp bends and are not pinched.</li> </ol>
Cooling system	If the flow through the system has been partly restricted, then rinse and clean.
Level sensors or other sensor equipment	<ol style="list-style-type: none"> <li>1. Check the functionality.</li> <li>2. Repair or replace any damaged equipment.</li> <li>3. Clean and adjust the equipment.</li> </ol>
Starter equipment	<ol style="list-style-type: none"> <li>1. Check the condition and functionality.</li> <li>2. Contact an electrician, if necessary.</li> </ol>
Insulation resistance in the stator	<ol style="list-style-type: none"> <li>1. Check the insulation between: <ul style="list-style-type: none"> <li>- Phase-phase on the stator</li> <li>- Phase-ground (earth)</li> </ul> <p>The insulation should be &gt; 1 megaohm. Use a 1000-VDC megger to test the insulation.</p> </li> <li>2. If the resulting value is &lt; 1 megaohm, then contact an authorized service shop.</li> </ol>

## Major overhaul

For a major overhaul, do the following in addition to the tasks listed under Inspection.

<b>Service item</b>	<b>Action</b>
Support and main bearing	Replace the bearings with new bearings.
Mechanical seal	Replace with new seal units.

## Change the oil

A paraffin oil with viscosity close to ISO VG32 is recommended. The pump is delivered from the factory with this type of oil. Examples of suitable oil types are the following:

- Statoil MedicWay 32™
- BP Enerpar M 004™
- Shell Ondina 927™
- Shell Ondina X430™

In applications where poisonous properties are of less concern, a mineral oil with viscosity up to ISO VG32 can be used.

<sup>1</sup> Regardless of individual applications, the inspection volume should not be inspected less frequently than the intervals for normal applications and operating conditions at media (liquid) temperatures <40°C (104°F).

## Empty the oil

1. Remove the oil screw.



---

### CAUTION: Compressed Gas Hazard

Air inside the chamber may cause parts or liquid to be propelled with force. Be careful when opening. Hold a rag over the plug to prevent liquid from spraying out.

---

2. Let the oil run out.



## Fill with oil

1. Remove the oil level screw.
2. Fill with new oil until it pours out from the oil level hole.  
Quantity: 11.4 L (12 qt.)

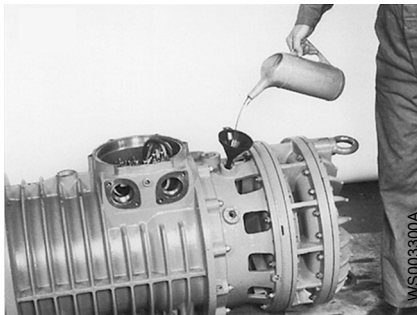

3. Replace the oil screw O-ring.
4. Put the oil screw back and tighten it.  
Tightening torque: 22 Nm (16 ft-lbs).

## Replace the impeller

### Remove the impeller: H





---

### CAUTION: Cutting Hazard

Worn parts can have sharp edges. Wear protective clothing.

---

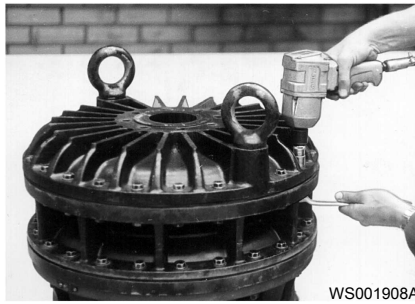
1. Unfasten the bolted joint that holds together the upper and lower rubber-coated diffuser rings for the outer impeller.



2. Insert a sling into the lifting eyes and lift away the upper diffuser ring. Note that the outer diffuser disc follows with it.



3. Remove the impeller:
  - a) Remove the impeller screw and the washer.



- b) Remove the outer impeller. Use two crowbars.
  - c) Remove the key.

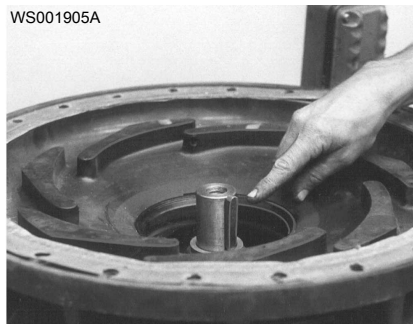

4. Remove the diffuser:
  - a) Remove the two strainer halves by undoing their fixing screws.
  - b) Disconnect the bolted joint. Note that every other bolt is screwed into the oil housing.
  - c) Remove the lower diffuser ring. Use a sling.



5. If you must remove the inner diffuser disc, do as follows:  
The inner diffuser disc is located inside the lower diffuser ring.
  - a) Remove the outer wear ring.  
Use two screwdrivers.
  - b) Remove the inner diffuser disc by removing the screws.
6. Remove the sleeve.  
If it is tight, use a puller. It may come loose when the inner impeller is prized loose.

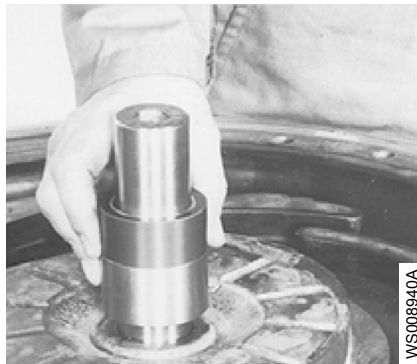

7. Remove the inner impeller.  
Use two crowbars.
8. Lift off the bottom diffuser ring and the adjustment washers for the inner impeller.



## Remove the impeller: N



### **CAUTION: Cutting Hazard**

Worn parts can have sharp edges. Wear protective clothing.

1. Remove the strainers.

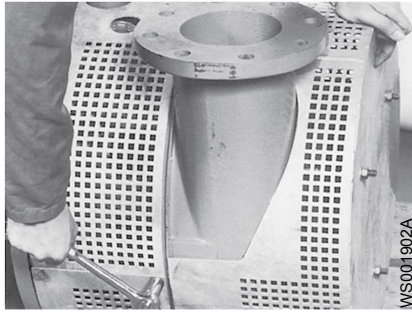

2. Remove the outer suction cover and the impeller.



Use a three-shanked puller if necessary.



3. Remove the screws from the pump housing.

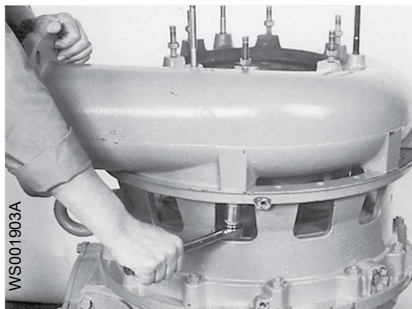

4. Remove the pump housing with the inner suction cover.

5. Detach the inner suction cover from the pump housing.





6. Proceed as for the H version, after the key has been removed.

## Install the impeller: H

1. Prepare the shaft:
  - a) Insert the key in the keyway of the shaft.
  - b) Fit an appropriate number of adjusting washers on the shaft.



2. Place the rubber-coated diffuser ring in position, and tighten it temporarily with a few bolts so that it is properly positioned. This is important for the following impeller adjustment.



3. Install the inner impeller:
  - a) Grease the shaft.
 

If the material of the impeller is stainless steel, then use suitable lubricant to prevent seizing.
  - b) Fit the inner impeller.

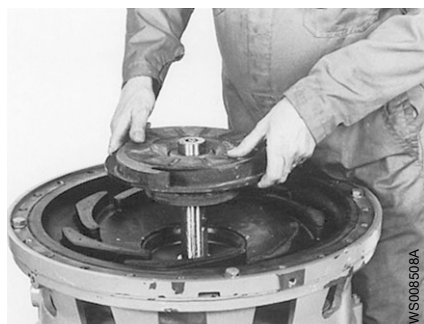

- c) Fit the sleeve onto the shaft.

If the sleeve has a darker part (silicon carbide), then fit the sleeve with the darker part facing up.



- d) Fit the diffuser disc into the diffuser ring, which must be located between the two impellers.
- e) Apply the adjusting tool to the diffuser ring.

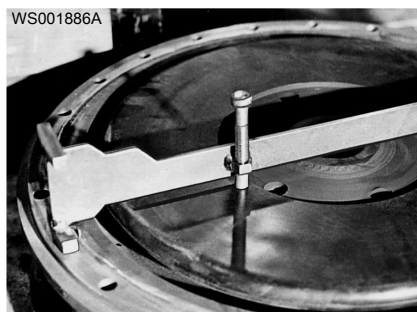

- f) Tighten the screw so that it barely touches the diffuser disc.
- g) Place the assembly sleeve over the shaft and firmly against the impeller. Use a torque wrench and tighten the impeller screw to 187 Nm (138 ft-lbs).  
The assembly sleeve is used to give the adjusting washers the right thrust.

4. Measure the clearance:

- a) Without disturbing the position of the screw, move the adjusting tool from the diffuser disc to the impeller while turning the tool 180°.



- b) Put the tool down and check that the clearance between the head of the screw on the tool and the impeller is 0.1–0.2 mm (0.004–0.008 in).  
If the clearance is outside this range, then adjust using the adjusting washers underneath the impeller.

5. Install the diffuser disc:

- a) Remove the assembly sleeve.
- b) Fit the diffuser ring with its diffuser disc.
- c) Tighten the bolts.

6. Install the outer wear ring:

- a) Lubricate the spring ring with soap.
  - b) Fit the spring ring onto the wear ring.
  - c) Press the outer wear ring into the diffuser.
- Use a rubber mallet.

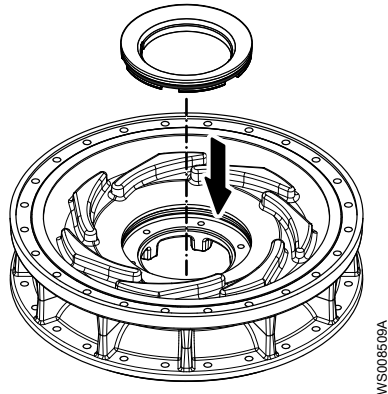

7. Install the outer impeller.

Repeat the same procedure that is used for installing the inner impeller to adjust and install the outer impeller but without using the assembly sleeve.

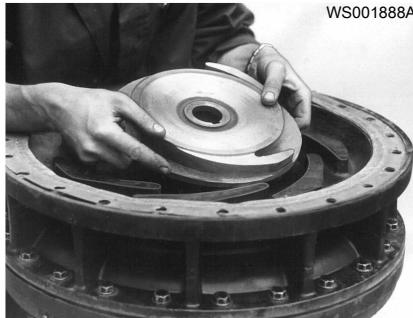

8. Install the diffuser ring:

- a) When the fine adjustment is finished, fit the top diffuser ring.
  - b) Check the fine adjustment by using a socket, an extension bar, and a handle.
  - c) Place the socket on the impeller screw. Turn the entire shaft with impellers around a few times to check that the impellers do not rub against the diffuser rings.
  - d) Fit the screw plug in the diffuser disc.
- Tightening torque: 187 Nm (138 ft-lbs).



In order for the pump to perform at maximum capacity, the impeller must be adjusted regularly.

## Install the impeller: N

1. Fit the sleeve and the keys onto the shaft.

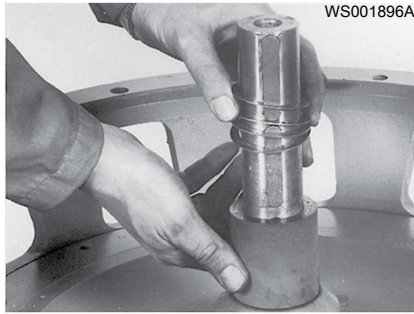

2. Fit the inner suction cover onto the pump housing.  
Check that the O-ring is lubricated and in place.

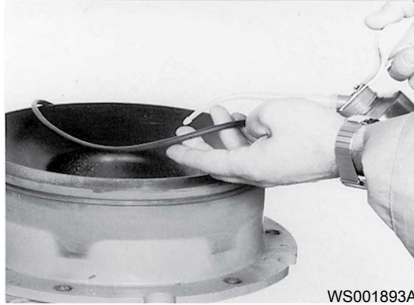

3. Position the suction cover in the withdrawn position so that the outer nuts engage a few threads.

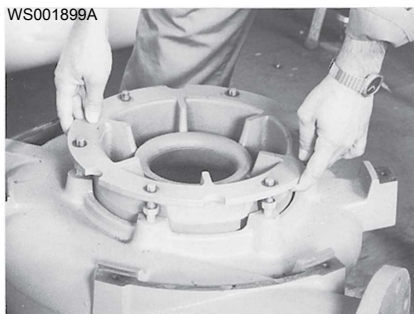

4. Fit the pump housing with its screws.

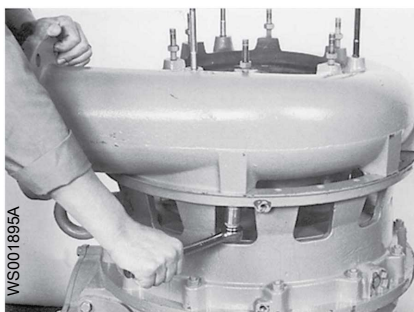

5. Install the impeller:
  - a) Grease the shaft  
If the material of the impeller is stainless steel, then use suitable lubricant to prevent seizing.
  - b) Mount the impeller with the longer hub end facing towards the motor.  
Check that the impeller is in the middle of the pump housing. Adjust if necessary with adjusting washers.

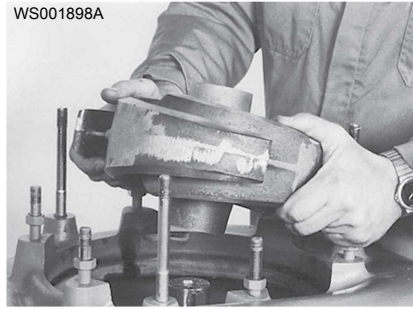

- c) Tighten the impeller using a torque wrench.  
Tightening torque: 187 Nm (138 ft-Ibs)
  - d) Finely adjust the inner suction cover against the impeller using the nuts so that a minimum and uniform clearance is obtained between the impeller and the suction cover.
6. Fit the outer suction cover and finely adjust it against the impeller using the nuts so that a minimum and uniform clearance is obtained between the impeller and the suction cover.
- Use a socket, extension bar, and handle on the impeller screw. Turn the shaft around during the fine adjustment to make sure that it is not seizing anywhere.

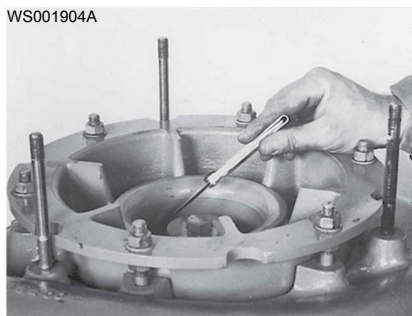

7. Fit the strainers.

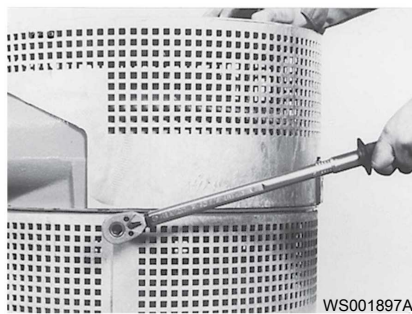

In order for the pump to perform at maximum capacity, the impeller must be adjusted regularly.

# Troubleshooting

## Introduction



---

### **DANGER: Electrical Hazard**

Troubleshooting a live control panel exposes personnel to hazardous voltages. Electrical troubleshooting must be done by a qualified electrician.

---

Follow these guidelines when troubleshooting:

- Disconnect and lock out the power supply except when conducting checks that require voltage.
- Make sure that no one is near the unit when the power supply is reconnected.
- When troubleshooting electrical equipment, use the following:
  - Universal instrument multimeter
  - Test lamp (continuity tester)
  - Wiring diagram

## The pump does not start



---

### **DANGER: Crush Hazard**

Moving parts can entangle or crush. Always disconnect and lock out power before servicing to prevent unexpected startup. Failure to do so could result in death or serious injury.

---

### **NOTICE:**

Do NOT override the motor protection repeatedly if it has tripped. Doing so may result in equipment damage.

---

<b>Cause</b>	<b>Remedy</b>
An alarm signal has been triggered on the control panel.	Check that: <ul style="list-style-type: none"> <li>• The impeller rotates freely.</li> <li>• The sensor indicators do not indicate an alarm.</li> <li>• The overload protection is not tripped.</li> </ul> If the problem still persists: Contact the local Grindex service shop.
The pump does not start automatically, but can be started manually.	Check that: <ul style="list-style-type: none"> <li>• The start level regulator is functioning. Clean or replace if necessary.</li> <li>• All connections are intact.</li> <li>• The relay and contactor coils are intact.</li> <li>• The control switch (Man/Auto) makes contact in both positions.</li> </ul> Check the control circuit and functions.

Cause	Remedy
The installation is not receiving voltage.	Check that: <ul style="list-style-type: none"> <li>• The main power switch is on.</li> <li>• There is control voltage to the start equipment.</li> <li>• The fuses are intact.</li> <li>• There is voltage in all phases of the supply line.</li> <li>• All fuses have power and that they are securely fastened to the fuse holders.</li> <li>• The overload protection is not tripped.</li> <li>• The motor cable is not damaged.</li> </ul>
The impeller is stuck.	Clean: <ul style="list-style-type: none"> <li>• The impeller</li> <li>• The sump in order to prevent the impeller from clogging again.</li> </ul>

If the problem persists, contact the local Grindex service shop. Always state the product number and the serial number of your pump when you contact Grindex, see [Product Description](#) (page 10).

## The pump does not stop when a level sensor is used



### **DANGER: Crush Hazard**

Moving parts can entangle or crush. Always disconnect and lock out power before servicing to prevent unexpected startup. Failure to do so could result in death or serious injury.

Cause	Remedy
The pump is unable to empty the sump to the stop level.	Check that: <ul style="list-style-type: none"> <li>• There are no leaks from the piping and/or discharge connection.</li> <li>• The impeller is not clogged.</li> <li>• The non-return valve(s) are functioning properly.</li> <li>• The pump has adequate capacity. For information: Contact the local Grindex service shop.</li> </ul>
There is a malfunction in the level-sensing equipment.	<ul style="list-style-type: none"> <li>• Clean the level regulators.</li> <li>• Check the functioning of the level regulators.</li> <li>• Check the contactor and the control circuit.</li> <li>• Replace all defective items.</li> </ul>
The stop level is set too low.	Raise the stop level.

If the problem persists, contact the local Grindex service shop. Always state the product number and the serial number of your pump when you contact Grindex, see [Product Description](#) (page 10).

## The pump starts-stops-starts in rapid sequence

Cause	Remedy
The pump starts due to back-flow which fills the sump to the start level again.	Check that: <ul style="list-style-type: none"> <li>• The distance between the start and stop levels is sufficient.</li> <li>• The non-return valve(s) work(s) properly.</li> <li>• The length of the discharge pipe between the pump and the first non-return valve is sufficiently short.</li> </ul>
The self-holding function of the contactor malfunctions.	Check: <ul style="list-style-type: none"> <li>• The contactor connections.</li> <li>• The voltage in the control circuit in relation to the rated voltages on the coil.</li> <li>• The functioning of the stop-level regulator.</li> <li>• Whether the voltage drop in the line at the starting surge causes the contactor's self-holding malfunction.</li> </ul>

If the problem persists, contact the local Grindex service shop. Always state the product number and the serial number of your pump when you contact Grindex, see [Product Description](#) (page 10).

## The pump runs but the motor protection trips



### **DANGER: Crush Hazard**

Moving parts can entangle or crush. Always disconnect and lock out power before servicing to prevent unexpected startup. Failure to do so could result in death or serious injury.

### **NOTICE:**

Do NOT override the motor protection repeatedly if it has tripped. Doing so may result in equipment damage.

Cause	Remedy
The motor protection is set too low.	Set the motor protection according to the data plate and if applicable the cable chart.
The impeller is difficult to rotate by hand.	<ul style="list-style-type: none"> <li>• Clean the impeller.</li> <li>• Clean out the sump.</li> <li>• Check that the impeller is properly trimmed.</li> </ul>
The drive unit is not receiving full voltage on all three phases.	<ul style="list-style-type: none"> <li>• Check the fuses. Replace fuses that have tripped.</li> <li>• If the fuses are intact, then notify a certified electrician.</li> </ul>
The phase currents vary, or they are too high.	Contact the local Grindex service shop.
The insulation between the phases and ground in the stator is defective.	<ol style="list-style-type: none"> <li>1. Use an insulation tester. With a 1000 V DC megger, check that the insulation between the phases and between any phase and ground is &gt; 5 megaohms.</li> <li>2. If the insulation is less, then do the following: Contact the local Grindex service shop.</li> </ol>



Cause	Remedy
The density of the pumped fluid is too high.	Make sure that the maximum density is 1100 kg/m <sup>3</sup> (9.2 lb/US gal) <ul style="list-style-type: none"> <li>• Change to a more suitable pump</li> <li>• Contact the local Grindex service shop.</li> </ul>
The ambient temperature exceeds the maximum ambient temperature.	The pump must not be used for such an application.
There is a malfunction in the overload protection.	Replace the overload protection.

If the problem persists, contact the local Grindex service shop. Always state the product number and the serial number of your pump when you contact Grindex, see [Product Description](#) (page 10).

## The pump delivers too little or no water



### **DANGER: Crush Hazard**

Moving parts can entangle or crush. Always disconnect and lock out power before servicing to prevent unexpected startup. Failure to do so could result in death or serious injury.

### **NOTICE:**

Do NOT override the motor protection repeatedly if it has tripped. Doing so may result in equipment damage.

Cause	Remedy
The impeller rotates in the wrong direction.	<ul style="list-style-type: none"> <li>• If it is a 3-phase pump without SMART™, then transpose two phase leads.</li> <li>• If it is a 3-phase pump with SMART™, then correct the internal wiring.</li> <li>• If it is a 1-phase pump, then do the following: Contact the local Grindex service shop.</li> </ul>
One or more of the valves are set in the wrong positions.	<ul style="list-style-type: none"> <li>• Reset the valves that are set in the wrong position.</li> <li>• Replace the valves, if necessary.</li> <li>• Check that all valves are correctly installed according to media flow.</li> <li>• Check that all valves open correctly.</li> </ul>
The impeller is difficult to rotate by hand.	<ul style="list-style-type: none"> <li>• Clean the impeller.</li> <li>• Clean out the sump.</li> <li>• Check that the impeller is properly trimmed.</li> </ul>
The pipes are obstructed.	To ensure a free flow, clean out the pipes.
The pipes and joints leak.	Find the leaks and seal them.
There are signs of wear on the impeller, pump, and casing.	Replace the worn parts.
The liquid level is too low.	<ul style="list-style-type: none"> <li>• Check that the level sensor is set correctly.</li> <li>• Depending on the installation type, add a means for priming the pump, such as a foot valve.</li> </ul>

If the problem persists, contact the local Grindex service shop. Always state the product number and the serial number of your pump when you contact Grindex, see [Product Description](#) (page 10).

# Technical Reference

## Motor data

Feature	Description
Motor type	Squirrel-cage induction motor
Frequency	50 or 60 Hz
Supply	3-phase
Starting method	Direct on-line Star-delta
Maximum starts per hour	30 evenly spaced starts per hour
Code compliance	IEC 60034-1
Voltage variation without overheating	±10%, provided that it does not run continuously at full load
Voltage imbalance tolerance	2%
Stator insulation class	H (180°C [360°F])

## Application limits

### Version code 390

Data	Description	
Liquid temperature	Maximum 40°C (104°F)	
pH of the pumped media	WCCR seal	3-14
	RSiC seal	2-10
Liquid density	1100 kg/m <sup>3</sup> (9.2 lb per US gal) maximum	
Depth of immersion	Maximum 75 m (250 ft)	
Other	For the specific weight, current, voltage, power ratings, and speed of the pump, see the data plate of the pump. For other applications, contact the local sales and service representative for information.	

### Version code 400/590

Data	Description
Liquid temperature	Maximum 40°C (104°F)
pH of the pumped media	6-13
Liquid density	1100 kg/m <sup>3</sup> (9.2 lb per US gal) maximum
Depth of immersion	Maximum 75 m (250 ft)

Data	Description
Other	For the specific weight, current, voltage, power ratings, and speed of the pump, see the data plate of the pump.  For other applications, contact the local sales and service representative for information.

## Specific motor data

### Version code 390: 3-phase, 50 Hz

Motor type:

- 2,965 rpm
- Rated output 85 kW (114 hp)
- Maximum power consumption 92 kW (123 hp)

Voltage (V)	Rated current (A)	Starting current (A)
380	146	1180
400	139-147	1245
415	134	1080
440	128	1150
500	111-112	980
525	105-106	875
550	101-103	920
690	81	715
1,000	56-57	515

### Version code 390: 3-phase, 60 Hz

Motor type:

- 3,560 rpm
- Rated output 95 kW (127 hp)
- Maximum power consumption 100 kW (133 hp)

Voltage (V)	Rated current (A)	Starting current (A)
380	159-162	1085-1205
400	155	1270
440	141	1155
460	132-135	985-1210
575	107-108	810-935
600	103	850

### Version code 400/590: 3-phase, 50 Hz

Motor type:

- 2,955 rpm
- Rated output 90 kW (120 hp)
- Maximum power consumption 95 kW (127 hp)

Voltage (V)	Rated current (A)	Starting current (A)
380	155	1,170
400	146–154	1,255
415	142	1,075
440	135	1,140
500	117–118	825
525	112	885
550	107–108	915
690	86	715
1,000	59–60	475

### Version code 400/590: 3-phase, 60 Hz

Motor type:

- 3,560 rpm
- Rated output 104 kW (140 hp)
- Maximum power consumption 110 kW (148 hp)

Voltage (V)	Rated current (A)	Starting current (A)
380	175–178	1,195
400	169	1,260
440	154	1,145
460	145–148	1,105
575	117–118	850
600	113	840

### Dimensions and weights: Version code 390/400, N

All measurements in the illustrations are in millimeters.

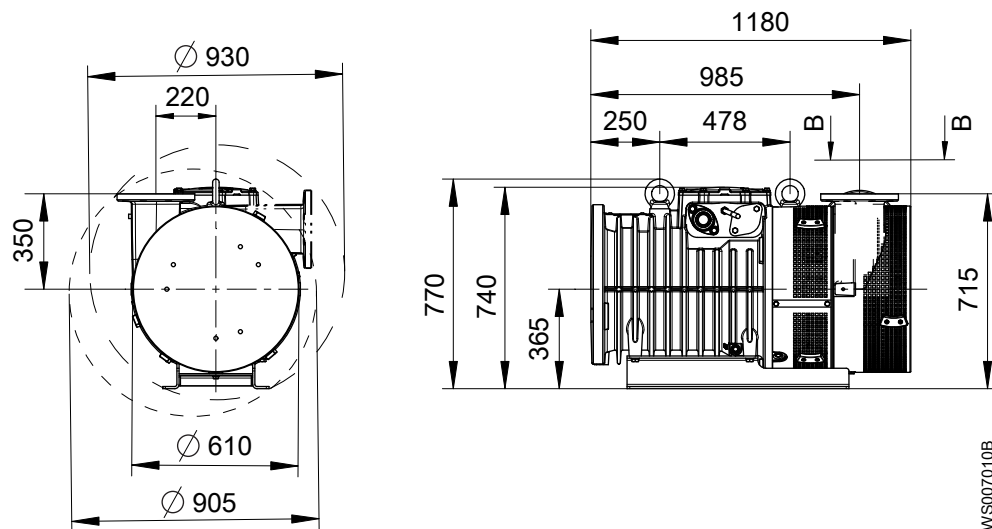

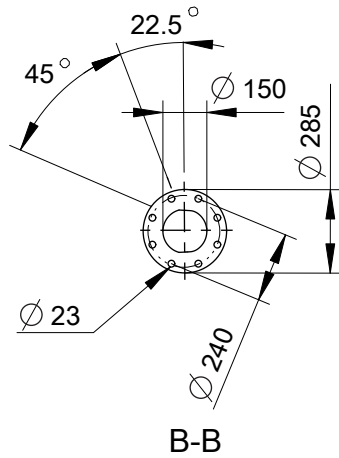

WS009731A

Version code	Weight without motor cable
8124.390	925 kg (2,039 lbs)
8124.400	900 kg (1,984 lbs)

## Dimensions and weights: Version code 390/400, H

All measurements in the illustrations are in millimeters.

### Dimensions, horizontal installation

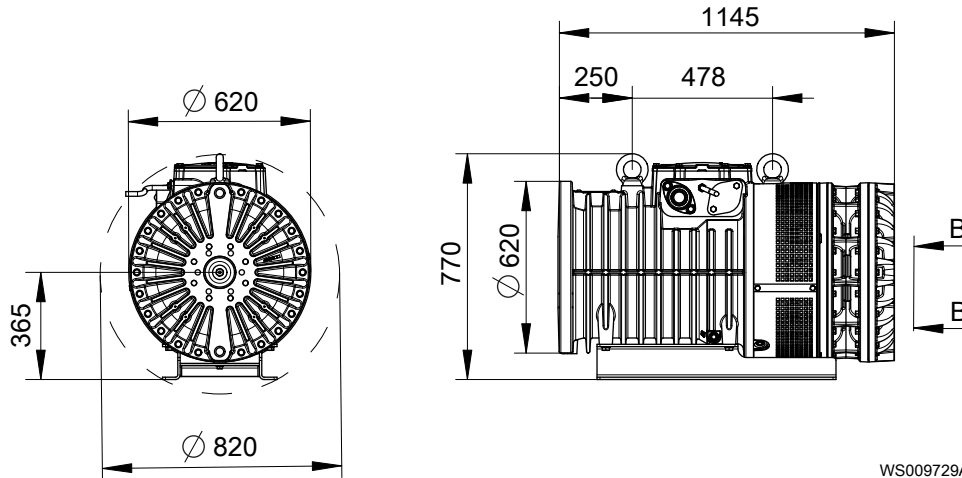

WS009729A

### Dimensions, vertical installation

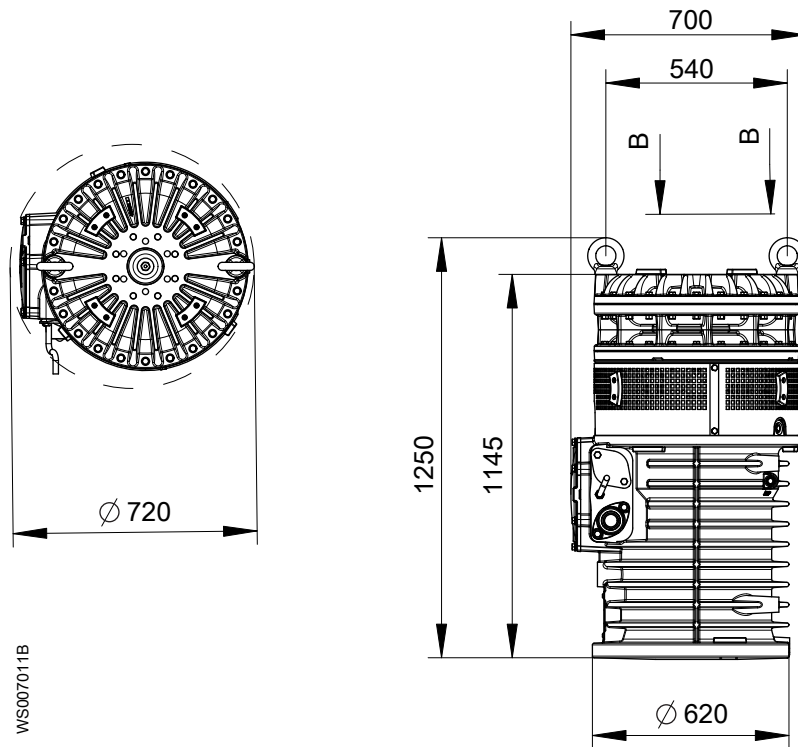

### View B-B, horizontal and vertical

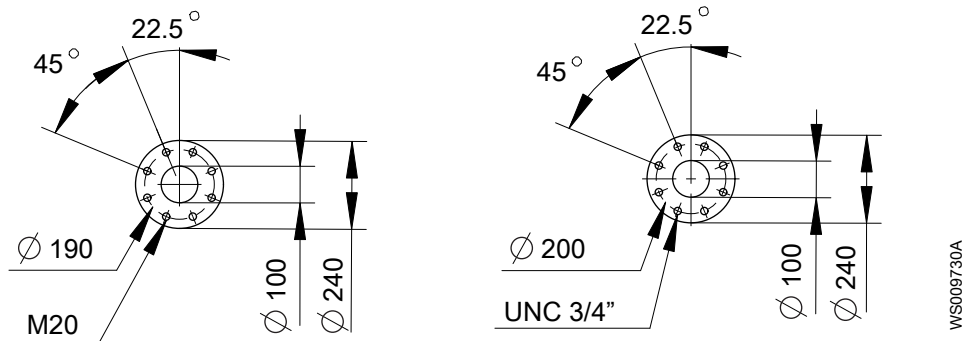

### Weights, horizontal and vertical

Version code	Weight without motor cable
8124.390	1,015 kg (2,238 lbs)
8124.400	985 kg (2,172 lbs)

## Dimensions and weights: Version code 590

### Dimensions

All measurements in the illustrations are in millimeters.

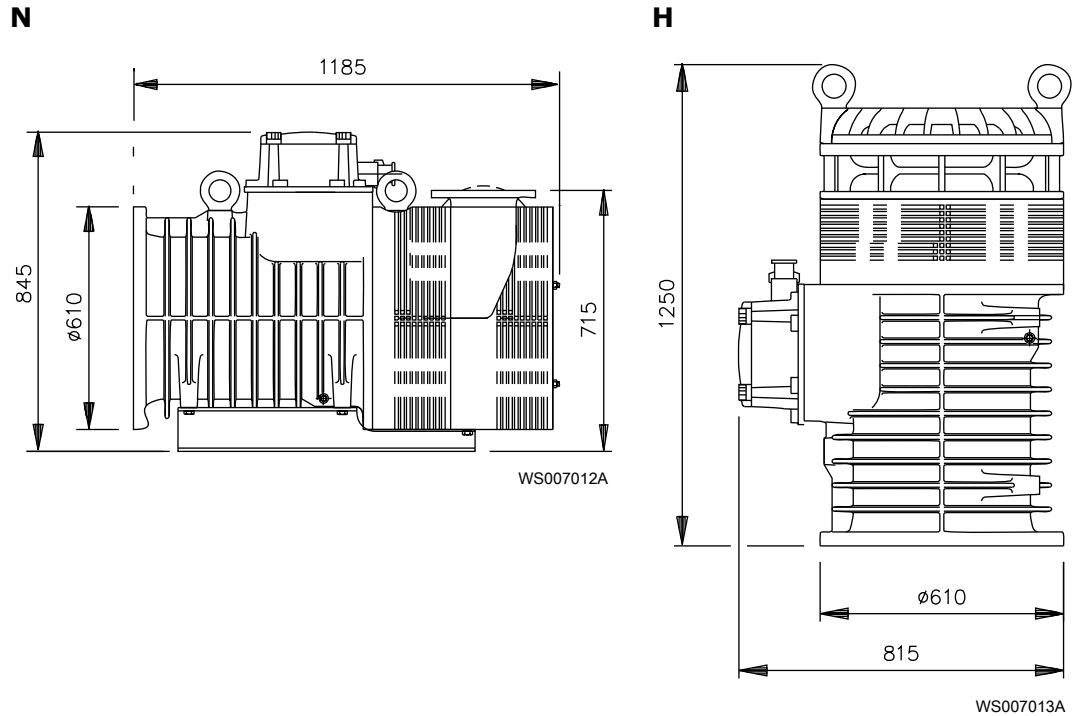

**Weights**

**Table 3: Weight without motor cable**

N	915 kg (2,017 lbs)
H	1,000 kg (2,205 lbs)

**Performance curves: Version code 390**

**Test standard**

Pumps are tested in accordance with ISO 9906:2012, HI 11.6:2012.



**50 Hz, version code 390**

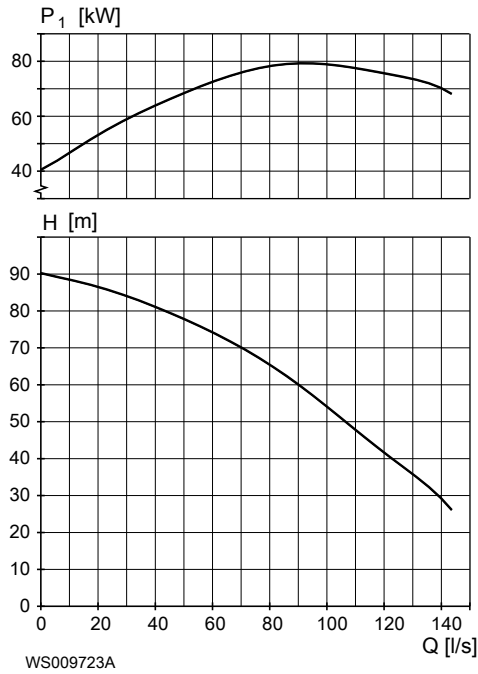

**Figure 5: N**

**Figure 6: H**

**60 Hz, version code 390**

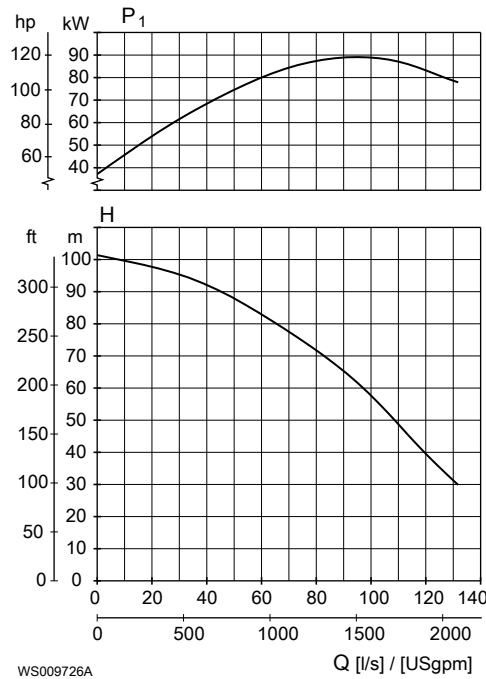

**Figure 7: N**

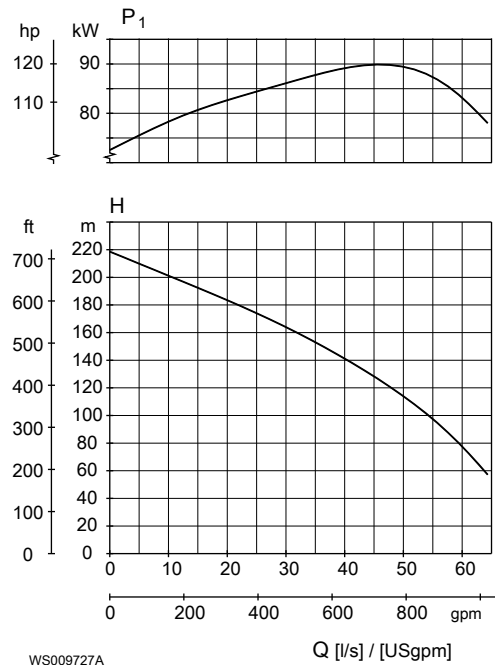

**Figure 8: H**

**Performance curves: Version code 400/590**

**Test standard**

Pumps are tested in accordance with ISO 9906:2012, HI 11.6:2012.

**Curves, version code 400/590**

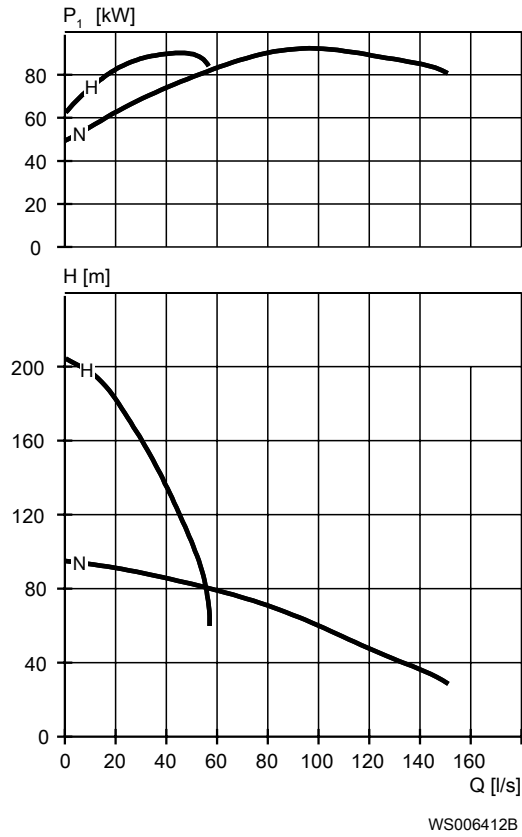

**Figure 9: 50 Hz**

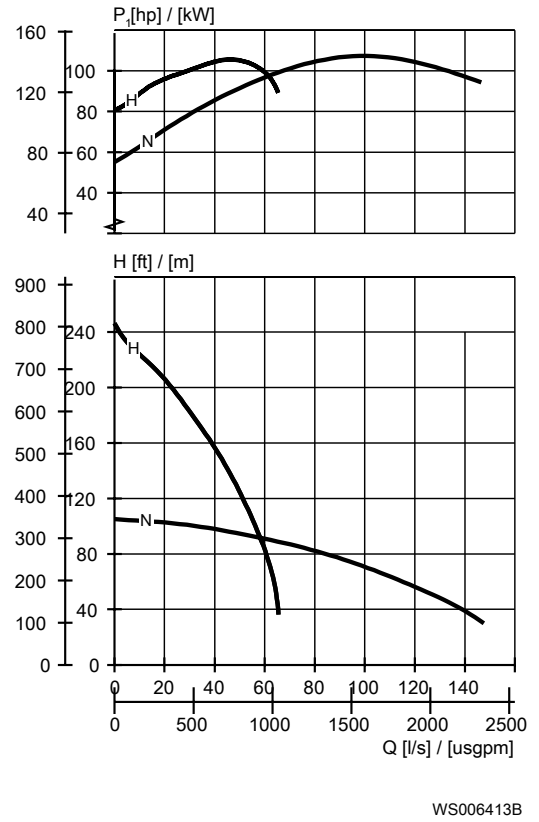

**Figure 10: 60 Hz**

WS006413B





Grindex  
Gesällvägen 33  
174 07 Sundbyberg  
Sweden  
Tel: +46-8-606 66 00  
Fax: +46-8-745 53 28  
[www.grindex.com](http://www.grindex.com)

Visit our Web site for the latest version of this document  
and more information

The original instruction is in English. All non-English  
instructions are translations of the original instruction.

© 2009 Grindex